

STEEL BUILDINGS RECOMMENDED INSTALLATION GUIDE

3 TO 30 METRE SPAN

TILT UP METHOD



SUPPLIED BY:

Last update – 8 December 2010
© 2010 FBHS (Aust) Pty Limited

This document remains the property of FBHS (Aust) Pty Ltd

FBHS (Aust) Pty Limited ABN 83 126 232 504 trading as Fair Dinkum Homes & Sheds. A member of the Fletcher Building Group
® a trade mark of FBHS (Aust) Pty Ltd

CONTENTS

1. TWO RECOMMENDED METHODS OF CONSTRUCTION	3
2. BEFORE YOU START	4
3. COMPONENTS/COMMON TERMS	6
4. BASIC TOOLS REQUIRED	19
5. GETTING STARTED	20
6. MAKING UP GIRTS & PURLINS	21
7. CREATING RAFTERS	22
8. CREATING COLUMNS	23
9. MAKING UP THE WALL FRAMES	26
10. SIDE WALL SHEETING	28
11. GUTTERING	29
12. OTHER SIDE WALL	30
13. STANDING WALLS	31
14. INSTALLING GABLE END WALL RAFTER	32
15. INSTALLING GABLE END WALL FRAMING	33
16. INSTALLING REMAINING RAFTERS	34
17. FIXING ROOF PURLINS	34
18. FIXING KNEE & APEX BRACES	35
19. GABLE END WALL GIRTS	36
20. FLY BRACING	36
21. GABLE END WALL CLADDING	37
22. CLADDING 2ND GABLE END WALL	39
23. ROOF SHEETING	39
24. FLASHINGS	40
25. DOWNPIPES	41
26. FINISHING	42
27. INSTALLATION OF SIDE WALL ROLLER DOOR	43
28. INSTALLATION OF GABLE END WALL ROLLER DOOR	46
29. INSTALLATION OF SIDE WALL PA DOOR	49
30. INSTALLATION OF GABLE END WALL PA DOOR	54
31. INSTALLATION OF SIDE WALL WINDOW	59
32. INSTALLATION OF GABLE END WALL WINDOW	63
33. INSTALLATION OF SIDE WALL GLASS SLIDING DOOR	67
34. INSTALLATION OF GABLE END WALL GLASS SLIDING DOORS	71

1. TWO RECOMMENDED METHODS OF CONSTRUCTION

THERE ARE TWO RECOMMENDED METHODS OF ERECTING THESE STRUCTURES

The installer will need to determine the most appropriate method for erecting the structure.

This recommended steel buildings installation guide contains METHOD NO 1 - the TILT UP method, where the side walls are assembled and clad on the ground and then lifted into position. This method is suitable for buildings:

**UNDER 9m SPAN; and
LESS THAN 3m HIGH; and
LESS THAN 12m IN LENGTH.**

IF YOUR BUILDING IS:

over 9m span; or
greater than 3m high; or
more than 12m in length;
or in adverse wind conditions.

Refer to: METHOD NO 2 - the FRAME FIRST method, where the framework is erected first, then clad and completed. This method may be used for large structures:

IF YOUR BUILDING HAS A:

Garaport Bay extension or a Lean-to on the side of the building,

Refer to: Recommended Instruction Guide for Garaport Bay extension & Lean-to's on the side of buildings.

IF YOUR BUILDING HAS A:

Mezzanine floor and staircase

Refer to: Recommended Instruction Guide for Mezzanine floors and Staircases.

IF YOUR BUILDING IS:

Horizontally clad,

Refer to: Recommended Instruction Guide for Horizontal Clad Buildings.

2. BEFORE YOU START

Prior to erecting your new building, please check that all local building authority requirements such as Building Applications are adhered to.

This is not a work safety manual, so it is important to follow relevant Occupational Health and Safety legislation, regulations and codes of practice. It is recommended that you do not work on buildings in damp conditions or walk on roof sheeting in damp or frosty conditions.

If a tradesman has been employed to erect the building, you should check with the state governing authority to verify licensing and insurance requirements for the contractor and any employees the contractor may employ.

This recommended instruction guide should be used in conjunction with the engineer's plans as submitted to your local authority.

Note: Information contained in engineering plans overrides details as shown in this instruction guide.

Our recommended "Shed Building Instructional DVD" is available from your 'Fair Dinkum' distributor, which should also be viewed as a guide only.

All dimensions for your building are to be taken from the accompanying engineering plans.

This guide is to be read in conjunction with:

1. Engineering plans supplied with the building.

The plans show all of the connection details for the specific building and contain elevation views of the building supplied. The "members schedule" will give particulars on member sizes and spacing, as well as other relevant information. This information can be found on sheet 5 of your plans. See example below.

ENGINEERING PLANS - EXAMPLE ONLY

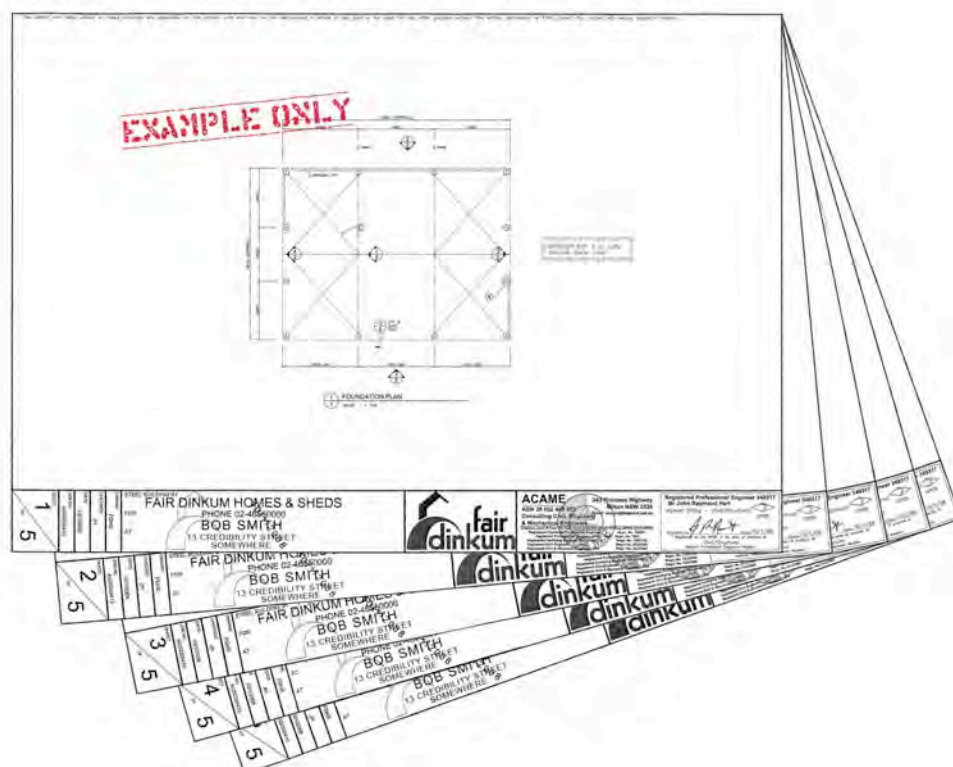



2. Bill Of Materials

This is a list of all components ordered for your building. You need to check it to ensure that you have received all components upon delivery. It also explains what each component is intended for.

BILL OF MATERIALS - EXAMPLE ONLY

Code	Number	Measure	Supplier	Description
ADV900K1485CTG	1	1.00m	AMIA	COTTAGE GREEN 0.900 x 1.485 Mtl Window - 26mm
ADV900K1485CTG	1	1.00m	AMIA	COTTAGE GREEN 0.900 x 1.485 Mtl Window - 26mm
- Sub Total - (4.75m) = \$260.00				
ADV900K1485CTG	10kg	1.00m	FEE	AGAT Service Fee - 10kg
- Sub Total - (3.00m) = Plus GST of \$15.50 = \$170.50				
SEN650CTG	1	4.00m	LANNOC	Shirley Access Door Kit CB COTTAGE GREEN # FA DOOR
SEN650CTG	1	4.00m	LANNOC	Shirley Access Door Kit CB COTTAGE GREEN # FA DOOR
- Sub Total - (7.75m) = Plus GST of \$39.00 = \$429.00				
RIF22277CTG	1	1.00m	RODUP	COTTAGE GREEN 2.20n x 2.77 CB TCM *FITSADOI 2/D # DOOR
MIF22244CTG	1	1.00m	RODUP	COTTAGE GREEN 2.20n x 2.44 CB TCM *FITSADOI 2/D # DOOR
MIF22277CTG	1	1.00m	RODUP	COTTAGE GREEN 2.20n x 2.77 CB TCM *FITSADOI 2/D # DOOR
RIF22277CTG	1	1.00m	RODUP	COTTAGE GREEN 2.20n x 2.77 CB TCM *FITSADOI 2/D # DOOR
- Sub Total - (26.00m) = Plus GST of \$135.70 = \$1,493.69				
MEC36CTG	13	3.11m	STRAN	COTTAGE GREEN Monoclad 0.41 CB # 60P SHEETS
MEC36CTG	14	3.025m	STRAN	COTTAGE GREEN Monoclad 0.41 CB # 60P SHEETS
MEC36CTG	2	3.09m	STRAN	COTTAGE GREEN Monoclad 0.41 CB # 60P SHEETS
MEC36CTG	1	1.44m	STRAN	COTTAGE GREEN Monoclad 0.41 CB # 60P SHEETS
MEC36CTG	1	3.15m	STRAN	COTTAGE GREEN Monoclad 0.41 CB # 60P SHEETS
MEC36CTG	2	1.39m	STRAN	COTTAGE GREEN Monoclad 0.41 CB # 60P SHEETS
MEC36CTG	2	1.28m	STRAN	COTTAGE GREEN Monoclad 0.41 CB # 60P SHEETS
MEC36CTG	1	3.22m	STRAN	COTTAGE GREEN Monoclad 0.41 CB # 60P SHEETS
MEC36CTG	1	2.81m	STRAN	COTTAGE GREEN Monoclad 0.41 CB # 60P SHEETS
MEC36CTG	4	3.55m	STRAN	COTTAGE GREEN Monoclad 0.41 CB # 60P SHEETS
QHI186LCTG	1	1.00m	STRAN	Quad In Front Concealed Gutter Base 2A-NSW ONLY # GUTTER HEAD
QHI186LCTG	2	1.00m	STRAN	Quad In Front Concealed Gutter Base 2A-NSW ONLY # GUTTER HEAD
QHI186LCTG	2	1.00m	STRAN	Quad In Front Concealed Gutter Base 2A-NSW ONLY # GUTTER HEAD
AGS71XCTG	2	3.55m	STRAN	COTTAGE GREEN Ridge Cap Monoclad 1.00 CB # 60P SHEETS
AGS71XCTG	1	2.3m	STRAN	COTTAGE GREEN Ridge Cap Monoclad 1.00 CB # 60P SHEETS
MC13MCTG	4	0.4m	STRAN	COTTAGE GREEN Centre End Wall - Million Flashing 150 CB # 75 WALL
MC13MCTG	4	0.52m	STRAN	COTTAGE GREEN Centre End Wall - Million Flashing 150 CB # 75 WALL
AGS79XCTG	2	2.4m	STRAN	COTTAGE GREEN Corner Flashing 75 x 75 CB # DOOR JAMB FLASHING
AGS79XCTG	2	2.4m	STRAN	COTTAGE GREEN Corner Flashing 75 x 75 CB # DOOR JAMB FLASHING
AGS79XCTG	1	2.7m	STRAN	COTTAGE GREEN Corner Flashing 75 x 75 CB # DOOR JAMB FLASHING
AGS79XCTG	1	2.4m	STRAN	COTTAGE GREEN Corner Flashing 75 x 75 CB # DOOR JAMB FLASHING
AGS79XCTG	1	2.91m	STRAN	COTTAGE GREEN Corner Flashing 75 x 75 CB # DOOR HEAD FLASHING
AGS79XCTG	1	2.59m	STRAN	COTTAGE GREEN Corner Flashing 75 x 75 CB # DOOR HEAD FLASHING
AGS79XCTG	1	2.91m	STRAN	COTTAGE GREEN Corner Flashing 75 x 75 CB # DOOR HEAD FLASHING
AGS79XCTG	2	2.91m	STRAN	COTTAGE GREEN Corner Flashing 75 x 75 CB # DOOR HEAD FLASHING
AGS79XCTG	1	2.91m	STRAN	COTTAGE GREEN Corner Flashing 75 x 75 CB # DOOR HEAD FLASHING
AGS79XCTG	1	2.4m	STRAN	COTTAGE GREEN Opening Trim 64 CB # DOOR JAMB TRIM FLASHING
AGS79XCTG	1	2.7m	STRAN	COTTAGE GREEN Opening Trim 64 CB # DOOR JAMB TRIM FLASHING
AGS79XCTG	1	2.4m	STRAN	COTTAGE GREEN Opening Trim 64 CB # DOOR JAMB TRIM FLASHING
AGS79XCTG	1	2.4m	STRAN	COTTAGE GREEN Opening Trim 64 CB # DOOR JAMB TRIM FLASHING
AGS79XCTG	1	2.91m	STRAN	COTTAGE GREEN Opening Trim 64 CB # DOOR HEAD TRIM FLASHING
AGS79XCTG	1	2.59m	STRAN	COTTAGE GREEN Opening Trim 64 CB # DOOR HEAD TRIM FLASHING
AGS79XCTG	1	2.91m	STRAN	COTTAGE GREEN Opening Trim 64 CB # DOOR HEAD TRIM FLASHING
AGS79XCTG	1	2.91m	STRAN	COTTAGE GREEN Opening Trim 64 CB # DOOR HEAD TRIM FLASHING
C10010	1	2.71m	STRAN	C10010 # DOOR HEADER
C10010	1	2.71m	STRAN	C10010 # DOOR HEADER
C10010	1	2.71m	STRAN	C10010 # DOOR HEADER
C10010	1	2.71m	STRAN	C10010 # DOOR HEADER
AGS79XCTG	1	2.91m	STRAN	COTTAGE GREEN Opening Trim 64 CB # DOOR HEAD TRIM FLASHING
XOB1002-U	20	1.00m	STRAN	End Wall Girt 100x50x3mm Steel # 60P SHEETS
XOB101H2	4	1.00m	STRAN	Base Cleat 30x50x30x3mm Steel # 60P SHEETS
XOB100M	4	1.00m	STRAN	Base Cleat 30x50x30x3mm Steel # 60P SHEETS
XOB1450-U	2	1.00m	STRAN	Mullion Flashing Angle D100 # 1.00m # WALLTOP TOP MULLION
DPC410050XCTG	2	2.4m	STRAN	COTTAGE GREEN Downdrip CB 100 x 50 # COMPILER
NOZ10050XCTG	2	1.00m	STRAN	NOZ10050 # COMPILER
XOB15042	6	1.00m	STRAN	120 x 50 x 75 x 1.00m Base Cleat C150 (1 Hole) - Plus # 60P SHEETS
XOB15042	2	1.00m	STRAN	120 x 50 x 75 x 1.00m Base Cleat C150 (1 Hole) - Plus # 60P SHEETS
XOB1150-PP	2	1.00m	STRAN	C150 Mtl 1150 1.00m Base Cleat C150 (1 Hole) - Plus # 60P SHEETS
XOB1150-PP	3	1.00m	STRAN	C150 Mtl 1150 1.00m Base Cleat C150 (1 Hole) - Plus # 60P SHEETS
XOB1150-PP	1	1.00m	STRAN	C150 Mtl 1150 1.00m Base Cleat C150 (1 Hole) - Plus # 60P SHEETS
C10010	1	2.5m	STRAN	C10010 # DOOR HEADER
XOB1450-V	2	1.00m	STRAN	Single Girt 1450 1.00m Base Cleat C150 (1 Hole) - Plus # 60P SHEETS
XOB1450-V	4	1.00m	STRAN	Single Girt 1450 1.00m Base Cleat C150 (1 Hole) - Plus # 60P SHEETS
C10010	4	3.0m	STRAN	C10010 # DOOR HEADER
PH6875-8800	9	3.0m	STRAN	PH6875 8800 3.00m # PURCHISE

/12/2007

3. COMPONENTS/Common Terms

The following is a description of each of the components used in construction.

COLUMNS

C Sections, which vary in size depending on the engineering requirements of the building. These may be single C Sections or back-to-back as specified on the engineering plans. These are the vertical members used to support rafters and wall girts, which are positioned at the appropriate bay spacings as required. Columns are also referred to as Gable End Wall columns and intermediate columns, depending on their location in the structure.

RAFTER

C Sections, which vary in size depending on the engineering requirements of the building. These may be single C Sections or back-to-back (regardless of the configuration of the columns) according to the engineering plans. They are joined together with apex brackets. Rafters are also referred to as Gable End Wall rafters and intermediate rafters, depending on their location in the structure.

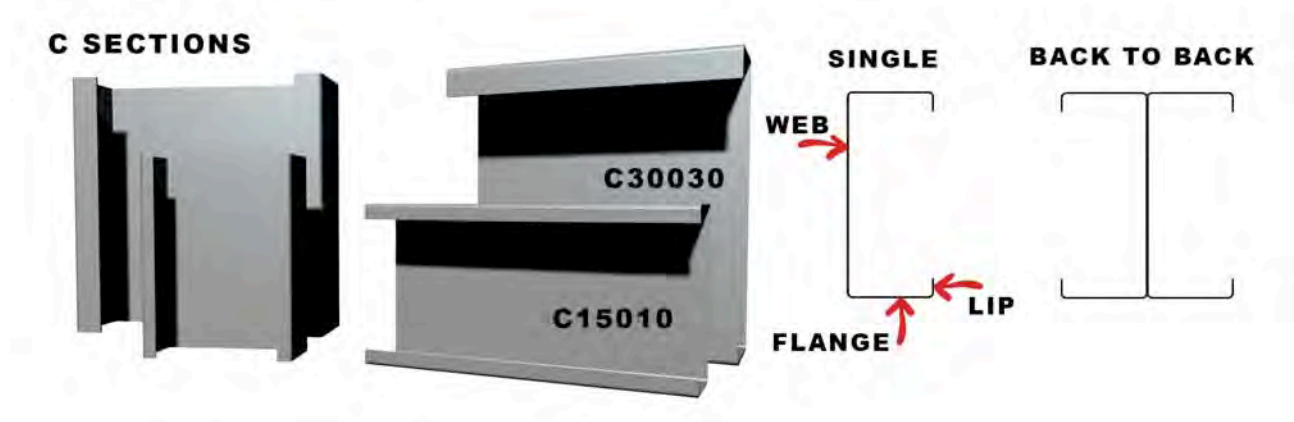

PORTAL FRAME

A portal frame consists of columns and rafters joined together with brackets and braces. Not all buildings have knee braces and/or apex braces, if they are required they will be specified on the engineering plans.

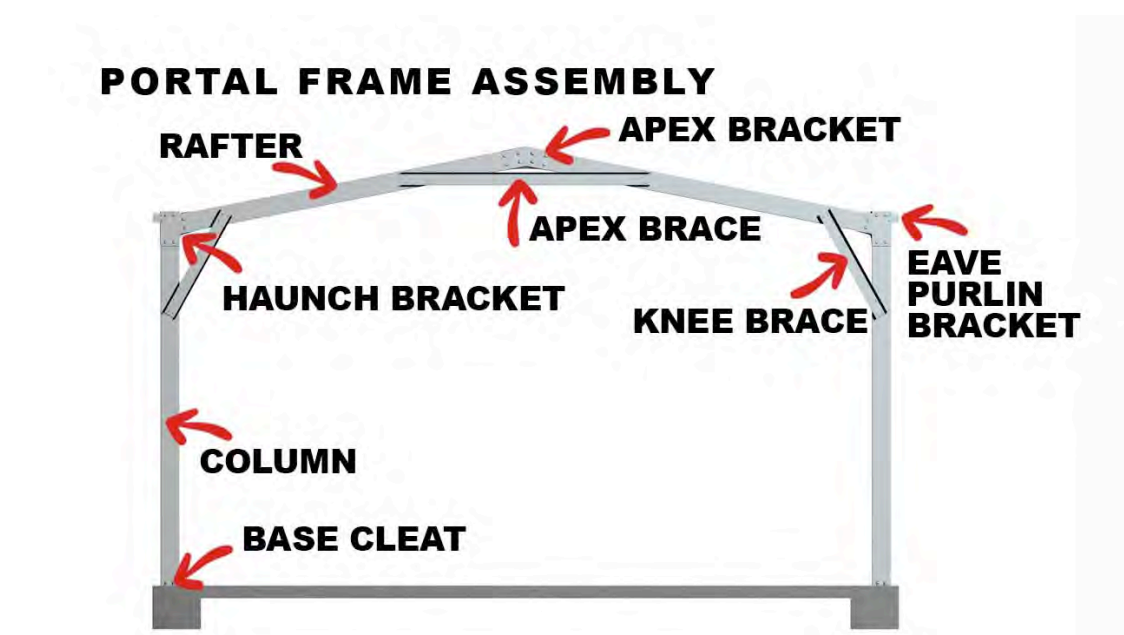

HAUNCH BRACKETS

These brackets are used to join the columns to the rafters. Haunch brackets must always be attached to the web face of the C Section. It is of great importance to follow the fixing procedure according to the engineering plans.

Note: Not all haunch brackets are pressed as below, but can be supplied as flat plates depending on the roof pitch and section sizes.

Note: Back-to-back portal connections may require 4 haunch brackets per portal frame. Check your Bill of Materials for clarification.

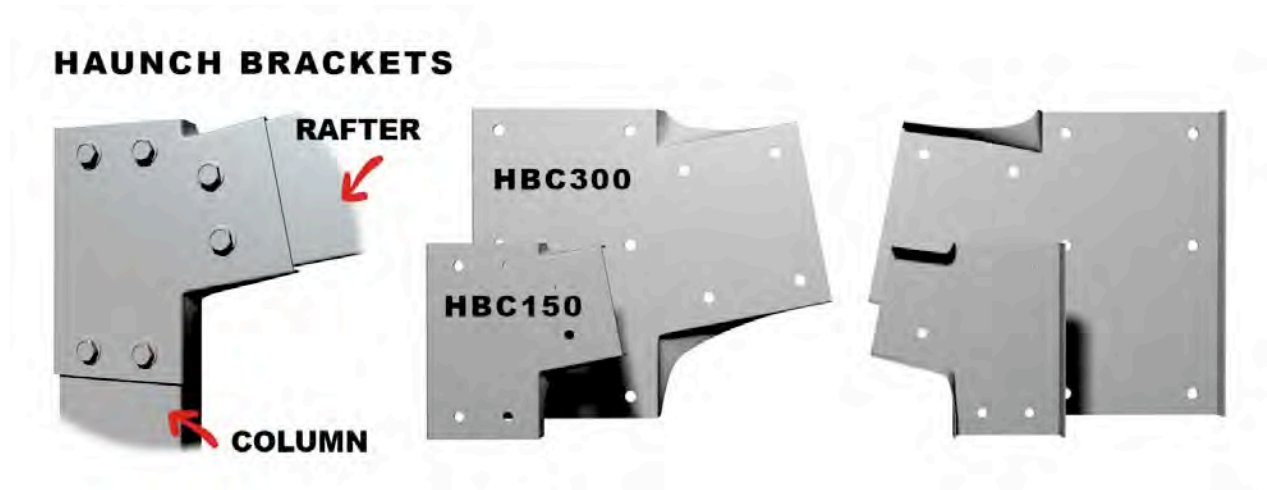

APEX BRACKETS

These brackets are used to join the two rafters to form the roof apex. Apex brackets must always be attached to the web face of the C Section. It is of great importance to follow the fixing procedure according to the engineering plans.

Note: Not all apex brackets are pressed as below, but can be supplied as flat plates depending on the roof pitch and section sizes.

Note: Back-to-back portal connections may require 2 apex brackets per portal frame. Check your Bill of Materials for clarification.



ROOF PURLINS

Roof purlins are either Z Sections or Tophats depending on the size and type of structure. They are “Tek” screwed or bolted to the top flange face of the rafters to support the roof cladding. Roof purlins run horizontally down the length of the building, parallel to the gutter. They are to be lapped over the rafters.

SIDE WALL GIRTS

Side wall girts are either Z Sections or Tophats depending on the size and type of structure. They are “Tek” screwed or bolted to the outside flange face of the columns to support the side wall sheets. Side wall girts run horizontally down the length of the building, parallel to the gutter. They are to be lapped over the columns.

GABLE END WALL GIRTS

Gable End Wall girts are either Z Sections or Tophats depending on the size and type of structure. They are “Tek” screwed or bolted to the inside flange face of each Gable End Wall column with an Gable End Wall girt bracket. The Gable End Wall girts run horizontally across the width of the building. If an Gable End Wall mullion is required, Gable End Wall girts will be “Tek” screwed or bolted to the outside flange face of the Gable End Wall mullion where they overlap.

Z SECTIONS & TOPHATS

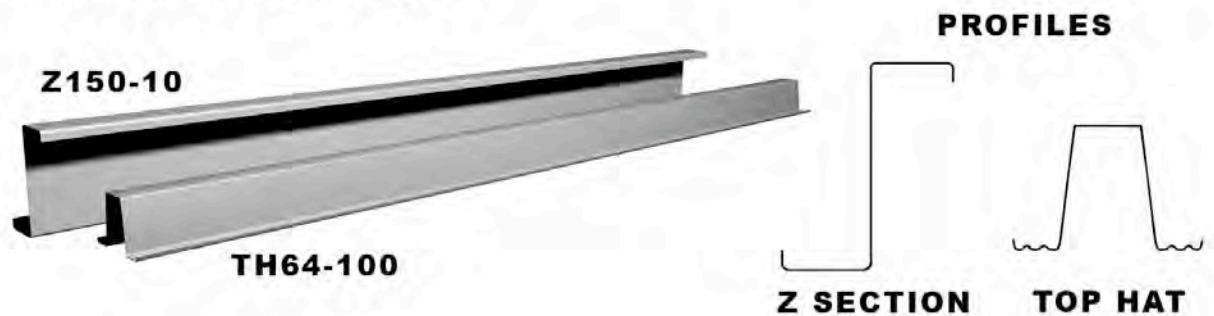

GABLE END WALL GIRT BRACKETS

Gable End Wall girt brackets are ‘L’ shaped brackets which join Gable End Wall girts to columns or roller door jambs; and door headers to door jambs.

GABLE END WALL GIRT BRACKET

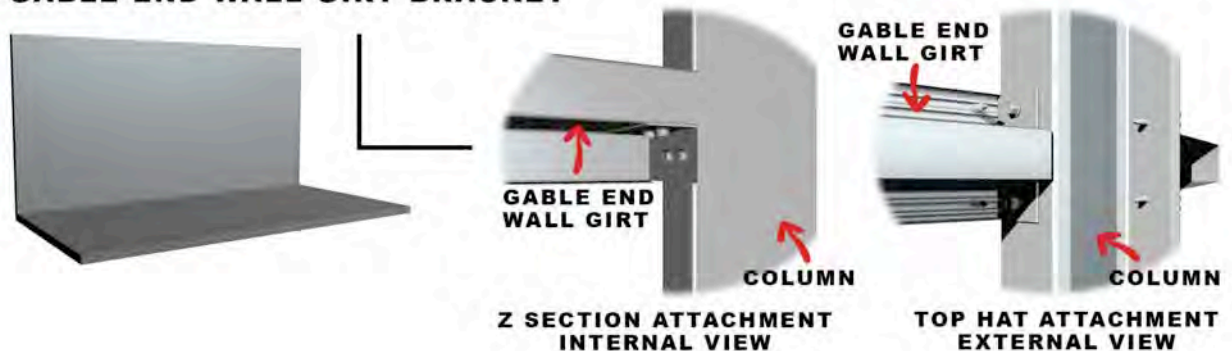

EAVE PURLINS

Eave Purlins are usually C Sections (but may be Z Sections or Tophats in some circumstances) used to support the top of the wall cladding, where it joins the roof cladding. The size of the eave purlin may vary from the rest of the C Sections, Z Sections or Tophats in the structure.

EAVE PURLIN BRACKETS

Eave Purlin Brackets are U-shaped brackets which are “Tek” screwed to one web face and one lip of the column to hold the eave purlin in place. The purpose of these brackets is to hold the eave purlin out and in line with the outside edge of the side girts. The location of the Eave Purlin Bracket on the column is detailed on sheet #5 of your plans in the ‘member and material schedule’.

Note: For back-to-back columns, double eave purlin brackets are used. These are screwed to the lip side of both columns.

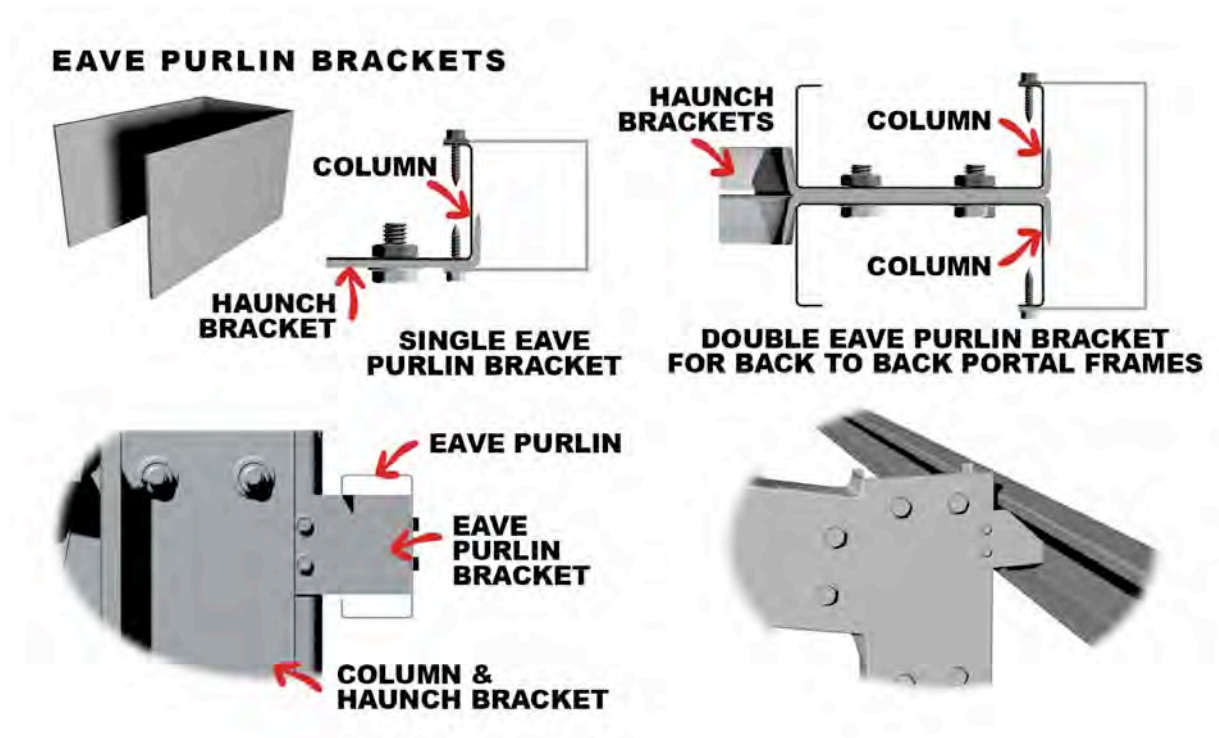

GABLE END WALL MULLIONS

Gable End Wall mullions are C Sections similar to the columns but perpendicular to the Gable End Wall. These are longer than the columns and extend to the top of the rafters. Each Gable End Wall mullion should be attached to the rafters with a mullion fixing angle bracket and attached to the footing or slab with a base cleat bracket (as per engineering plans).

MULLION FIXING ANGLE BRACKETS

Mullion fixing angle brackets are 'L' shaped brackets, which are "Tek" screwed or bolted (as per the engineering plans) to the web face at the top of the Gable End Wall mullions and to the web face of the rafter.

Centre Gable End Wall mullions are situated directly behind the apex bracket of the Gable End Wall portal frame. The mullion fixing angle bracket is "Tek" screwed or bolted (as per the engineering plans) to the web face at the top of the column on one side, and through the Apex Bracket into the web face of the rafter on the other side.

Mullion Fixing Angle Brackets may also be used to connect the Gable End Wall door jambs to the rafters.

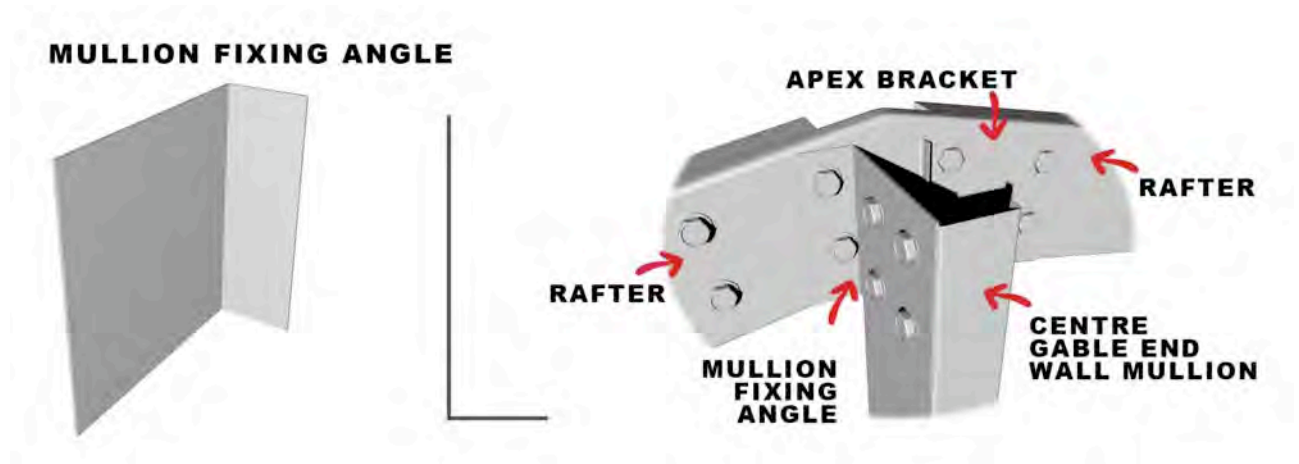

BASE CLEATS

Base cleats brackets are also 'L' shaped brackets, which are "Tek" screwed or bolted (as per engineering plans) to the web face at the base of columns, Gable End Wall mullions or door jambs on one side, and attached to the footing or slab with anchor bolts or hold down bolts (as per engineering plans) on the other side. Where a double column is used, attach a base cleat to the inside of each back-to-back column.

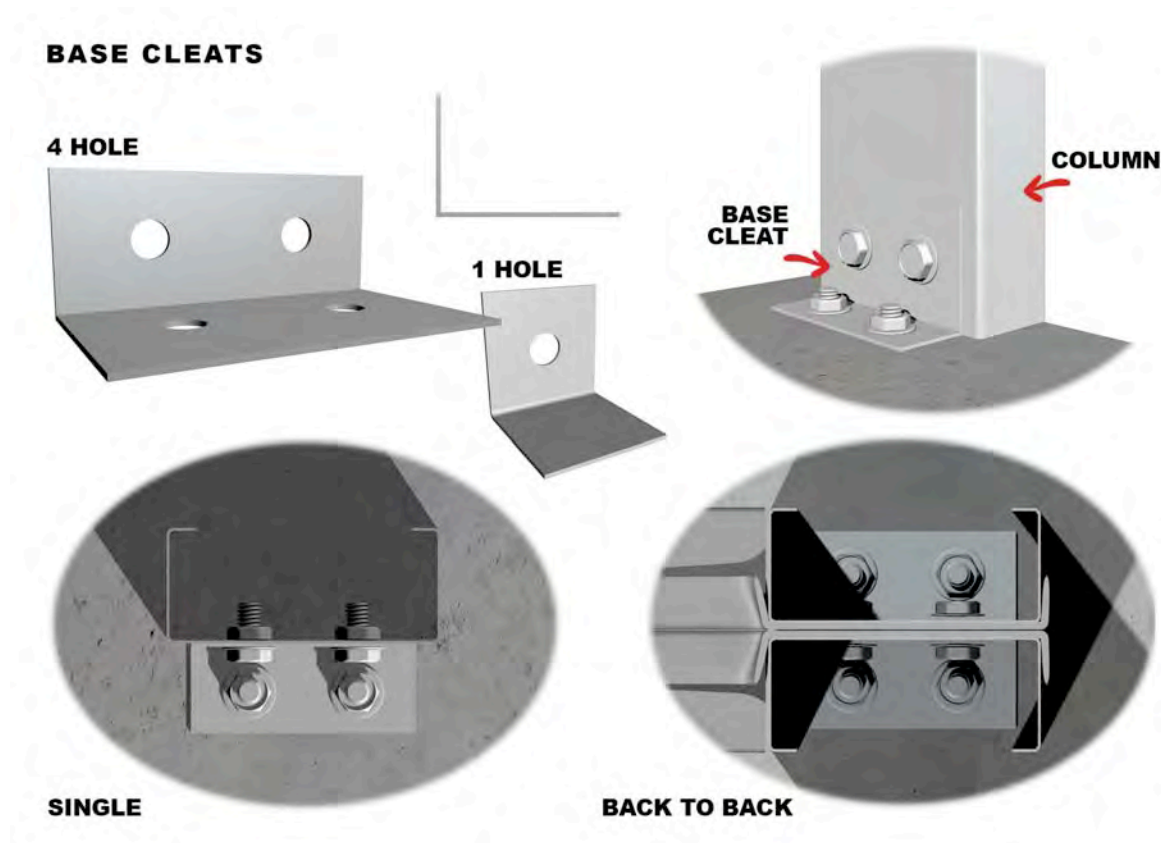

APEX BRACES

Apex braces are C Sections that connect and reinforce both rafters in each portal frame assembly (except the Gable End Wall portal frames where mullions are to be installed). The brace is “Tek” screwed or bolted to the web face of both rafters (as per engineering plans). These are not used on all buildings. Refer to the engineering plans.

APEX BRACE

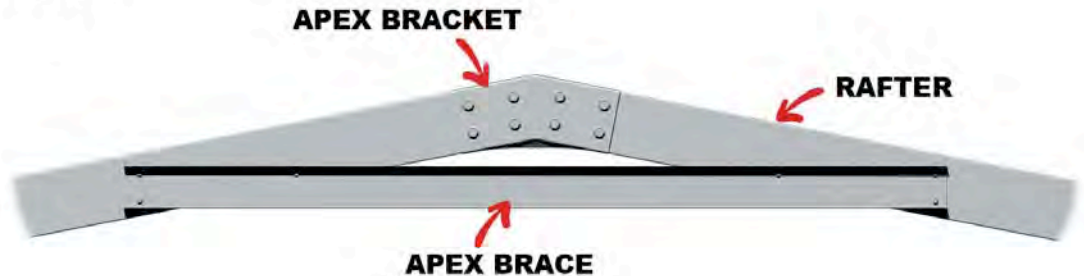

Note: Under NO circumstances are the Apex Braces to be fitted to the lips of the C Section.

KNEE BRACES

Knee braces are C Sections that connect and reinforce the columns and the rafters in each portal frame assembly. These braces are used on all portal frames (except the Gable End Wall portal frames where openings are to be installed). The brace is “Tek” screwed or bolted to the web face of each column and rafter (as per engineering plans). These are not used on all buildings. Refer to the engineering plans.

Note: Under NO circumstances are the Knee Braces to be fitted to the lips of the C Section.

KNEE BRACE

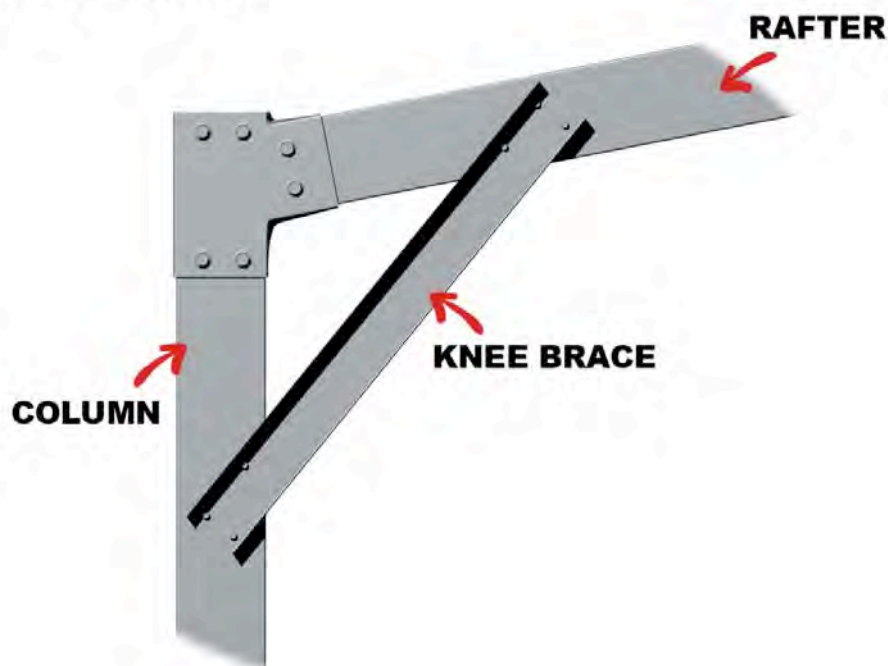

BRACING STRAP – CROSS BRACING

Bracing Strap is galvanised strapping which comes in a 50m roll and is cut to length on site. It is used to create Cross Bracing in walls and roofs, which are required on some buildings to provide extra stability and resist wind loads (movement caused by strong winds). Refer to engineering plans for type, size, location and connection details.

BRACING STRAP - CROSS BRACING



BRACING STRAP - FLY BRACING

Fly bracing is also galvanised strapping, (the same as the cross bracing strap), which is “Tek” screwed to the underside of the rafter and the roof purlin (in the roof), and/or the inside of the column and the side wall girt (in the side walls). It is required on some buildings to provide extra stability and resist wind loads (movement caused by strong winds). Refer to engineering plans for usage requirements.

BRACING STRAP - FLY BRACING



DOOR JAMBS FOR ROLLER DOORS, LARGE WINDOWS & GLASS SLIDING DOORS

GABLE END WALL DOOR JAMB

An Gable End Wall door jamb is a C section (the same size as the main columns), which forms the side frame work of the door opening in an Gable End Wall. It fits under the rafter and is "Tek" screwed or bolted to the web face of the rafter with a mullion fixing angle (as per engineering plans). It is attached to the slab or footing with a base cleat bracket.

GABLE END WALL DOOR JAMB



SIDE WALL DOOR JAMB

A side wall door jamb is a length of folded galvanised section which fits around the wall girt to form the side frame work of the door opening. The door jamb will either extend to the eave purlin or to the next girt above the opening as illustrated below. It is attached to the slab or footing with a base cleat type bracket (Refer to Bill Of Materials for exact bracket).

SIDE WALL ROLLER DOOR JAMB

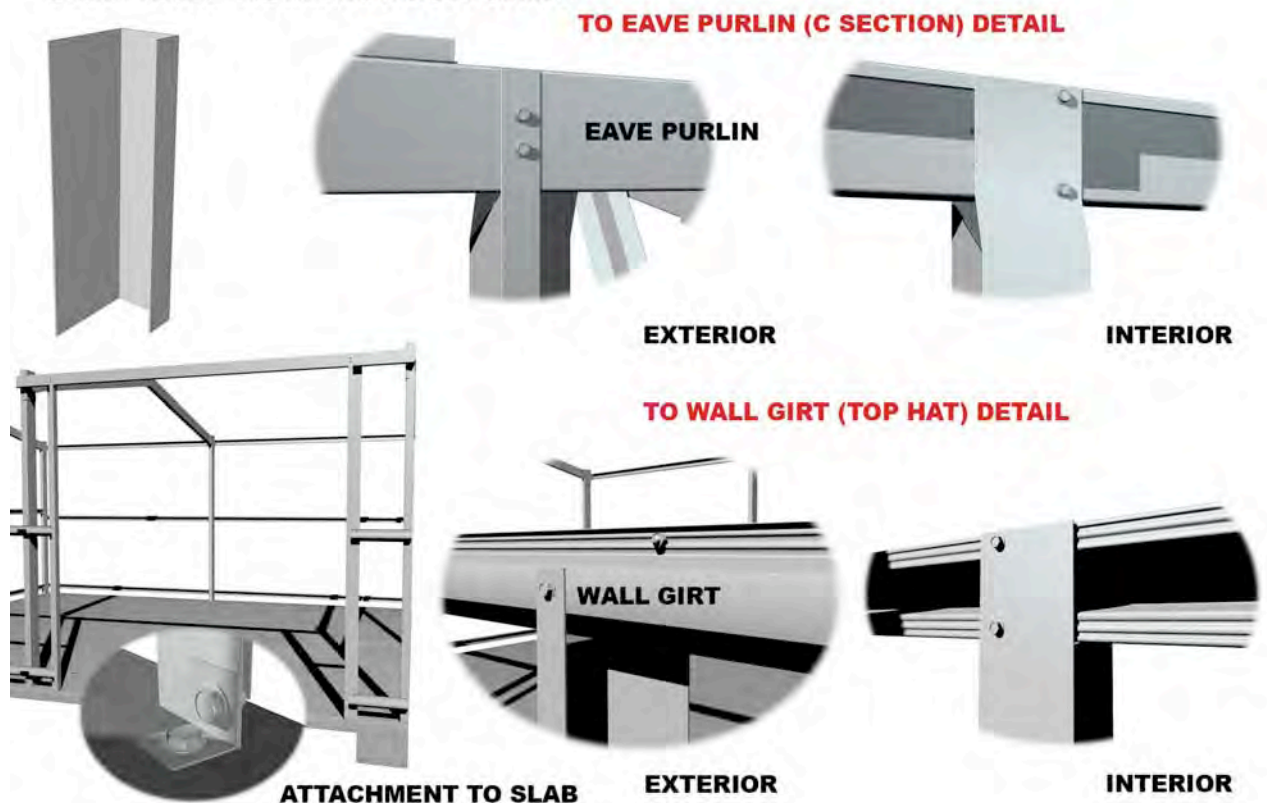

ROLLER DOOR AND GLASS SLIDING DOOR HEADER

A door header is a C Section. It is fitted between the door jambs to form a header above the door which is used to attach the wall sheeting above the door. They are secured at each end to the door jambs using an Gable End Wall girt bracket and "Tek" screws.

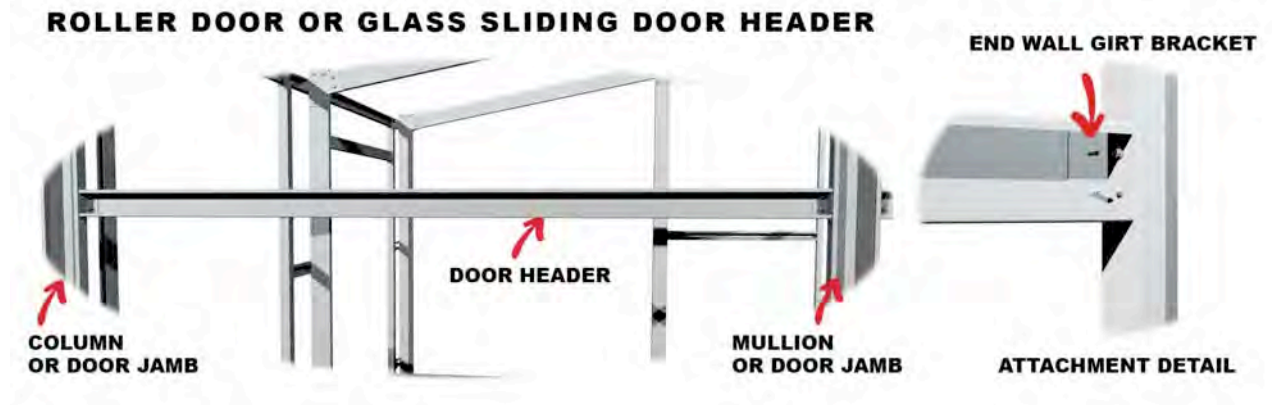

P.A. (Personal Access) DOOR JAMBS

These are similar to the door jambs mentioned previously. They form the opening for the P.A. Door to fit into.

ROOF & WALL SHEETS

Roof and wall sheeting is fixed to the wall girts and roof purlins using the screws provided. See engineering plan for fixing details.

ROOF & WALL SHEETS



RIDGE CAP

This covers the space between the two runs of roof cladding at the apex of the roof (ridge). Below is a diagram of a typical Ridge Cap.

RIDGE CAP

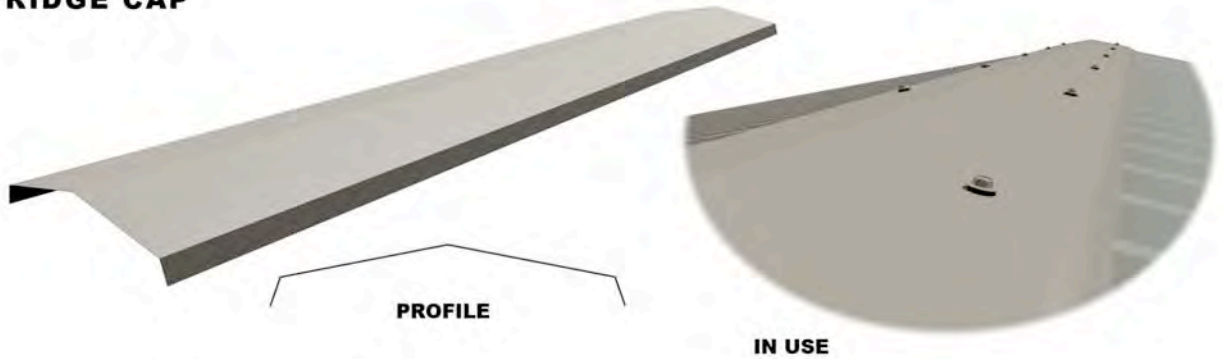

BARGE CAP

This covers the space between the roof and the wall cladding at the gable ends of the building. It is fixed to the roof cladding with "Tek" screws and to the wall cladding with pop rivets. Below is a diagram of a typical Barge capping.

BARGE CAP

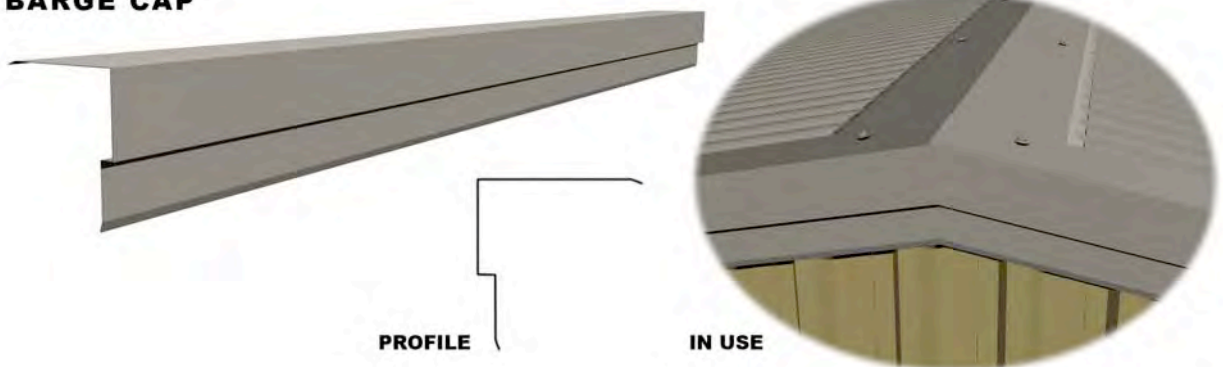

GUTTERING

Guttering is fitted to the top of the sidewall cladding to collect rainwater from the roof sheets. Gutter brackets are riveted onto the ribs of the wall sheets to hold the shape of the gutter and to stop it from collapsing under peak volume.

STOP ENDS

Stop ends are used to seal gutter ends. They are pop riveted and sealed into position.

GUTTER & PARTS

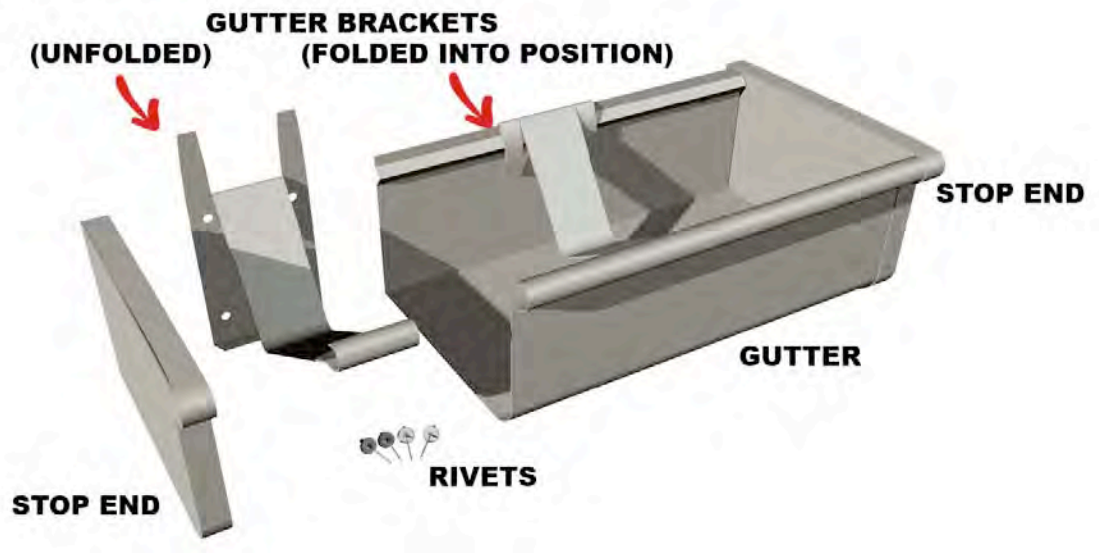

DOWNPIPE & NOZZLE

Downpipes are connected to the guttering using a downpipe nozzle to carry the rainwater to ground level.

DOWNPIPE & NOZZLE

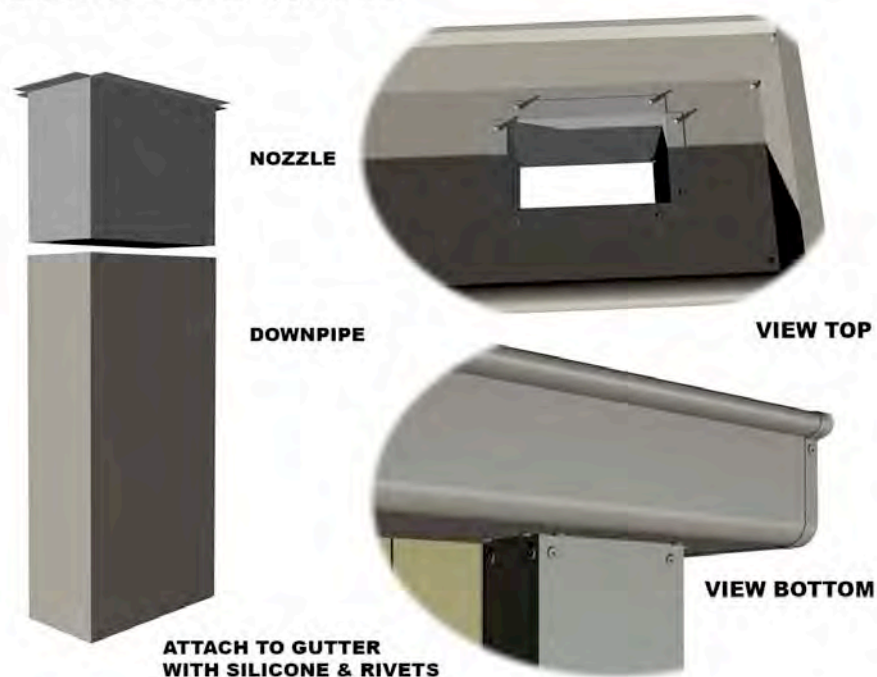

CORNER FLASHING

Corner flashings are used to cover the join between end and side wall sheets at each corner of the building. They are also used as door flashings.

CORNER FLASHINGS

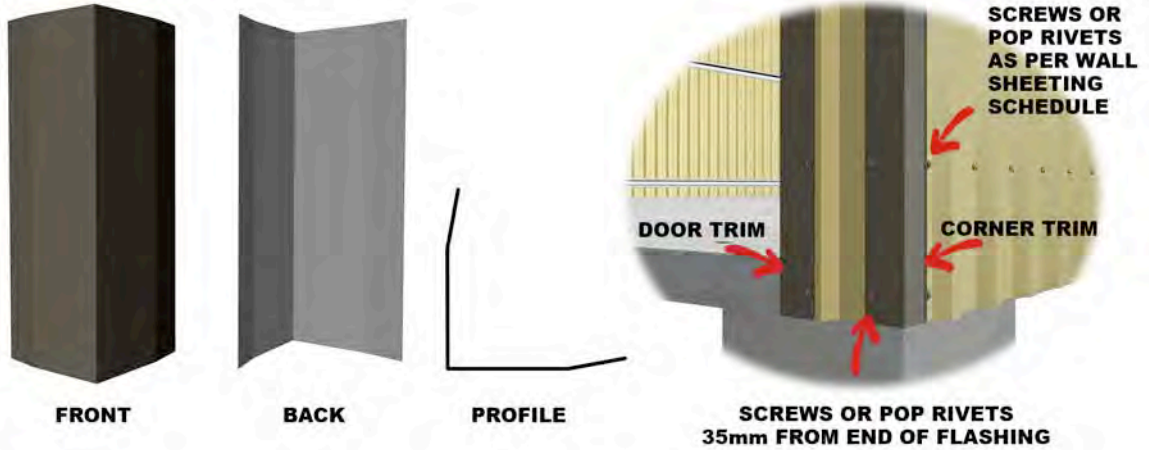

SCREWS

Wall Screws - To fix the wall cladding to the wall girts (these are the smallest screw supplied).
 Frame Screws - To fix brackets to the framework and purlins/girts to the frame.
 Roofing Screws - To fix the roof sheets/flashings into the roof purlins. (this screw comes with a neoprene washer & in some circumstances a cyclone cap).

POP RIVETS

To fix corner flashings, trim angles and barge capping to the wall cladding. Also to fix guttering and downpipes to downpipe nozzle.

STRUCTURAL FRAME BOLTS

These bolts are used to attach columns, rafters and brackets together to form portal frames. There are two types of bolt sets (check engineering plans).

HOLD DOWN BOLTS

These will vary depending on the wind rating and the size of the building. They may be either sleeve anchor or 'U' bolts (check engineering plans).

BOLTS SCREWS & POP RIVETS

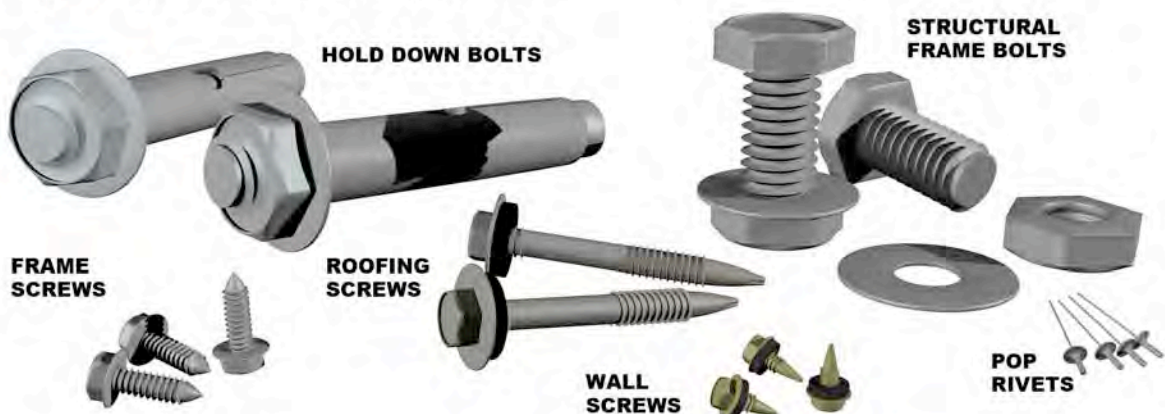

FOUNDATIONS

The most common type of foundation for these buildings is a concrete slab. It is important that your slab and/or footings comply with the accompanying engineer's details.

The slab size must be the exact dimensions of the building i.e. If your building measures 6m x 7m, then the slab measurement should be exactly 6m x 7m. Building measurements are taken from inside of cladding to inside of cladding.

If using footings other than a slab, refer to the supplier of this manual for an output for the dimensions of the specific footing required. All piers as required by engineering plans, must be cleaned out to remove any loose soil, with the columns located in the centre of the pad or pier.

Note: Foundations are required to be both diagonally square and level before starting. If the foundations are not square and level, this can cause problems when erecting the building, which may cause construction costs to increase.

FOUNDATIONS - CONCRETE SLAB



4. BASIC TOOLS REQUIRED

Hammer

Small and long Tape Measures

Quick release clamps

Snips

Socket Set

Silicone and Applicator

Rivet Gun

Stanley Knife

Multigrips or pliers

Permanent marker and a pencil

Chalk line with preferably blue chalk

String lines

Spirit level (if on piers you will need a laser level or dumpy level)

Square

Screw Drivers

'Tek' screw Gun or Electric Drill with a Clutch and appropriate bits for screws in kit

(For head size(s) check with the supplier of this manual)

Electric Drill (a battery drill will also be very handy)

Nibbler

Angle Grinder - DO NOT USE NEAR ANY COLORBOND FENCING, MOTOR

VEHICLES OR GLASS

Note: When using an angle grinder please ensure the operator has been trained in the safe handling of angle grinders, such as the wearing of safety goggles and following relevant safety regulations in relation to the use of power tools.

Hammer drill

Extension leads

Approved Power boards (with Residual Current Device's)

A soft haired brush to remove swarf

Note: When zinc and/or Colorbond sheets are cut, it is important to sweep the edge of the metal with a soft haired brush to remove the 'swarf'. Should any 'swarf' remain on the product after cutting it may cause rusting and this may void the warranty.

5. GETTING STARTED

MARKING OUT THE BUILDING

The location of the inside of the column on the side wall needs to be marked with a chalk line down both lengths of the side wall (see diagram below). This measurement called FRAME-DIST, is calculated by adding the width of the column (C Section) and the side wall girt (Tophat or Z Section) together.

The distance in between the columns called RAFT-DIST needs to be calculated. To do this, subtract (2 x FRAME-DIST) from the total width of the building. This distance is measured across the span of the slab from chalk line 1 to create chalk line 2 (see diagram below).

CALCULATING "FRAME DIST"

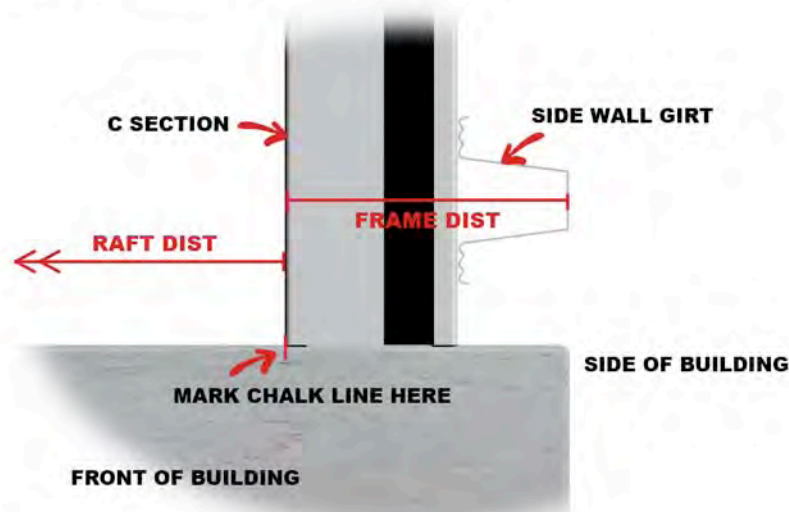

CALCULATING "RAFT DIST"

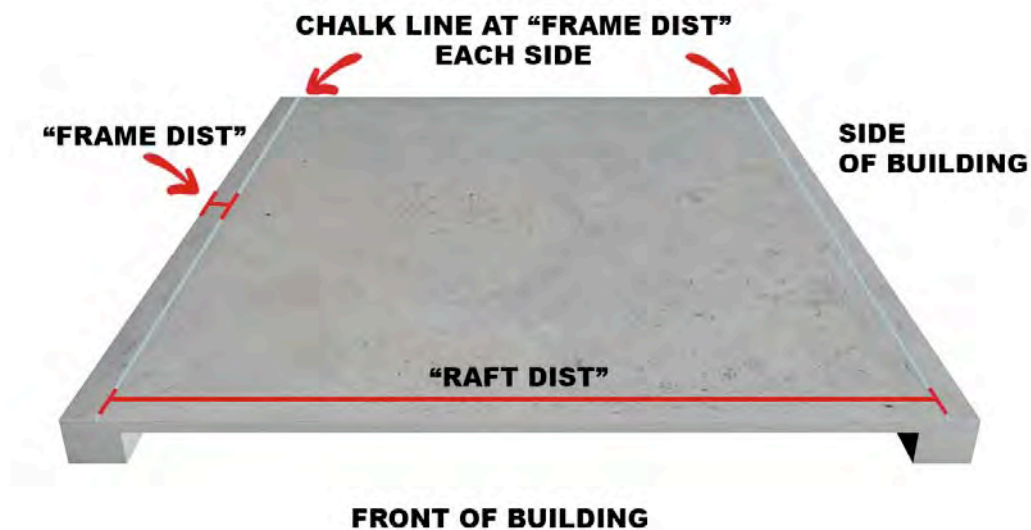

6. MAKING UP GIRTS & PURLINS

Lay out your side wall girts and roof purlins onto your slab. Check your BOM to ensure you have the correct length sections. Then, join them together with overlap to suit the length of the building, ensuring all overlaps are equal on buildings with more than 2 bays.

For ease of handling it is recommended that girts & purlins be joined together in multiples of no more than 2 at a time. Once joined, mark the position of the intermediate portal frames onto the Tophat or Z Section using a permanent marker.

LOOKING UP GIRT & PURLIN LENGTHS ON YOUR BILL OF MATERIALS

Code	Number	Measure	Supplier	Description
TH6475-3600	8	3.6m	STRAM	Tophat 64/75 Stock Length 3,600 @ SIDE GIRTS
TH6475-2900	8	2.9m	STRAM	Tophat 64/75 Stock Length 2,900 @ END GIRTS
C15015	6	2,807m	STRAM	C15015 35w/2662w/2772w @ RAFTERS

SIDE WALL GIRTS & ROOF PURLINS

OVERLAP CONNECTION DETAIL



MEASURE & MARK POSITION OF INTERMEDIATE PORTAL FRAMES

TEK SCREW EITHER SIDE OF GIRT OR PURLIN AT EACH END OF OVERLAP AS PER YOUR ENGINEERING PLANS

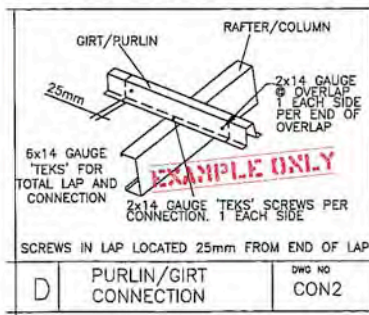

SUPPLIED LENGTHS

OVERLAPPED TO SUIT LENGTH OF BUILDING

7. CREATING RAFTERS

Lay 2 rafters and 1 apex bracket (assuming single frame), web side up on the foundation at the approximate roof pitch. Ensure that the C Sections meet at the apex. Place 2 screws (one in each rafter) securing the apex bracket into position. Measure long point to long point of rafters and adjust until this measurement equals RAFT-DIST. "Tek" screw or bolt the apex bracket securely into position (as per engineering plans). Stand rafters side by side and mark the position for the roof purlins on the rafter with a permanent marker or crayon, (quantity and spacing as per engineering plans) and put aside until required.

The diagram below shows an optional way of inserting a temporary frame screw at the bottom of each purlin.

Note: In some case the 'RAFT-DIST' measurement must be adjusted depending on the Roof Pitch and the size of the C Sections in the building. Exceptions to the rule are listed in the table below.

'RAFT DIST' EXCEPTIONS TABLE – mm added to EACH SIDE of RAFT DIST measurement

	5	11	15	22	30	45
C150	-	-	-	0.3	7	31.9
C200	-	-	-	5.2	19.5	56.9
C250	-	-	-	-	2	-
C300	-	-	-	-	15	-
C400	-	-	-	-	-	-

RAFTER ASSEMBLY

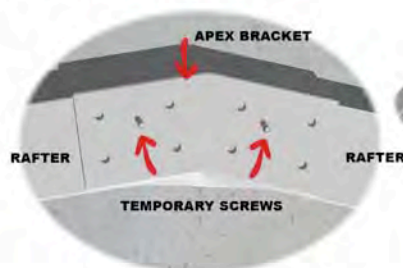

MEASURE AND ADJUST RAFTER TO EQUAL "RAFT DIST"



FIX RAFTERS TO APEX BRACKETS AS PER ENGINEERING PLANS

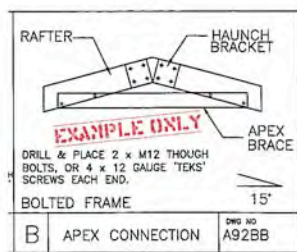

ENSURE RAFTERS MEET AT APEX

MARKING ROOF PURLIN POSITION ON RAFTER ASSEMBLY

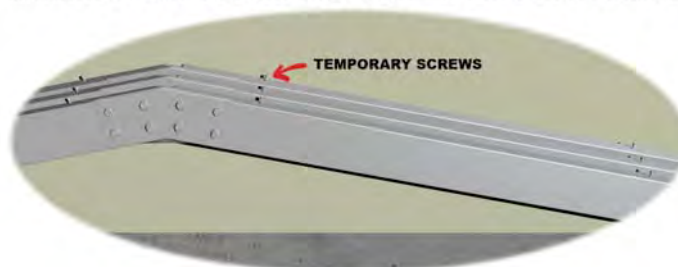

8. CREATING COLUMNS HAUNCH BRACKETS

Lay columns flat on the slab down both side walls at the approximate bay spacings.

CALCULATING EVEN BAY SPACINGS

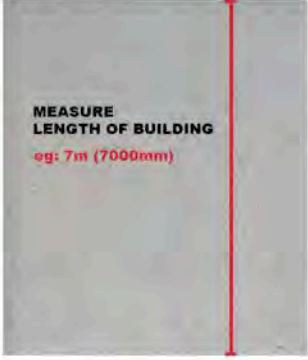

MEASURE LENGTH OF BUILDING
eg: 7m (7000mm)

MEASURE FLANGE DIMENSION OF COLUMNS
eg: 64mm



COUNT NUMBER OF PORTAL FRAMES
eg: 3



COUNT NUMBER OF BAY SPACINGS
eg: 2

CALCULATION:

MULTIPLY FLANGE DIMENSION OF COLUMN BY NUMBER OF PORTAL FRAMES
eg: 64mm x 3 = 192mm

SUBTRACT THIS AMOUNT FROM THE LENGTH OF THE BUILDING
eg: 7000mm - 192mm = 6808mm

DIVIDE THIS AMOUNT BY THE NUMBER OF BAY SPACINGS REQUIRED
eg: 6808mm / 2 = 3404mm

eg: RESULT 3404mm

THE RESULTING NUMBER WILL BE THE EXACT MEASUREMENT BETWEEN PORTAL FRAMES

Attach a haunch bracket to the web face of each column. When placing the left and right handed haunch brackets onto the columns ensure that the web face of each intermediate column will face the front of the building when built (giving the building more aesthetic appeal). Ensure that the top of the bracket is flush with the top of the column. One "Tek" screw is placed in the bracket to hold it in place. Then it is fully fixed off according to engineering plans.

Note: Front & Rear portals must have the web of the columns facing in towards the centre of the building. This is for aesthetics, and may also be used to attach gable end roller doors to.

CREATING COLUMNS - HAUNCH BRACKET CONNECTION



COLUMNS & HAUNCH BRACKETS LAID OUT ON SLAB

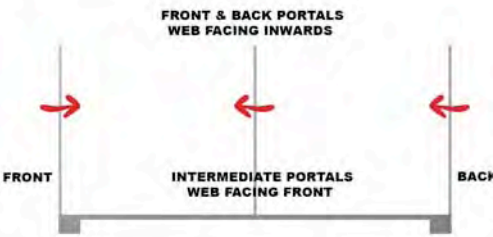

**FRONT & BACK PORTALS
WEB FACING INWARDS**

FRONT **INTERMEDIATE PORTALS
WEB FACING FRONT** **BACK**

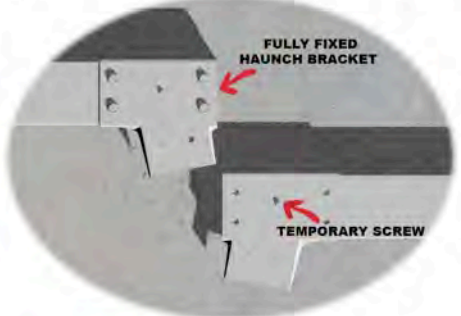

**FULLY FIXED
HAUNCH BRACKET**

TEMPORARY SCREW

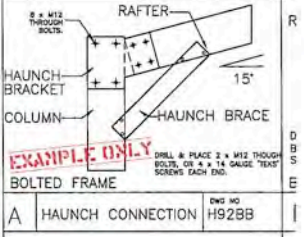

EXAMPLE ONLY

8 x M12 THROUGH BOLTS

RAFTER

HAUNCH BRACKET

COLUMN

HAUNCH BRACE

15°

DRILL & REACE 2 x M12 THROUGH BOLTS, OR 4 x 14 GAUGE 'TEK' SCREWS EACH END.

BOLTED FRAME

A	HAUNCH CONNECTION	ENG NO	H92BB
---	-------------------	--------	-------

BASE CLEAT BRACKETS

Fix a base cleat bracket to the web face at the base of each column. Where double columns are used base cleats are fixed to the inside of both C Sections.

Note: it may be necessary to offset base cleats on the columns that roller doors are to be fitted to, to allow for roller door tracks.

CREATING COLUMNS - BASE CLEAT CONNECTION

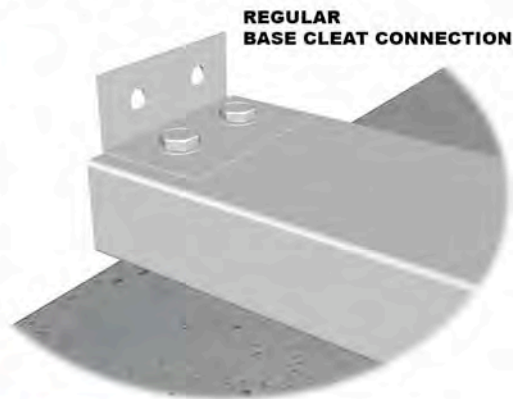
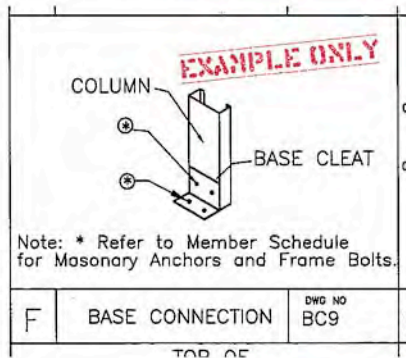

**REGULAR
BASE CLEAT CONNECTION**

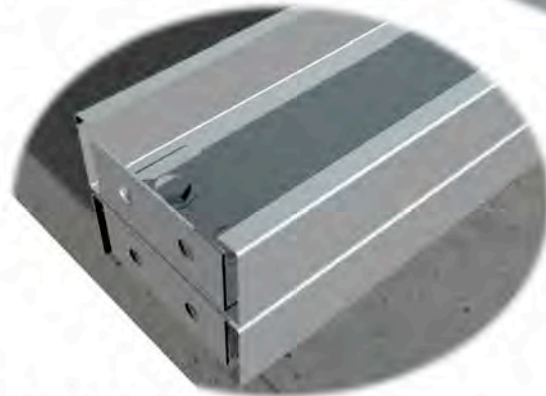

**DOUBLE COLUMN
BASE CLEAT CONNECTION**

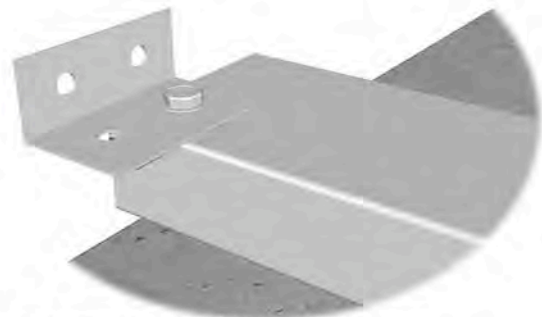

**OFFSET BASE CLEAT CONNECTION
MAY BE REQUIRED IF COLUMN IS BEING USED
AS A ROLLER DOOR JAMB**

EAVE PURLIN BRACKETS

An eave purlin bracket is attached to the top of each column using 2 frame screws per side of the bracket.

The eave purlin bracket needs to be at the height stipulated in the member & material schedule (sheet #5 of plans), depending on the FRAME SIZE & ROOF PITCH.

Repeat this process for the other columns.

CREATING COLUMNS - EAVE PURLIN BRACKET CONNECTION

REGULAR EAVE PURLIN BRACKET CONNECTION

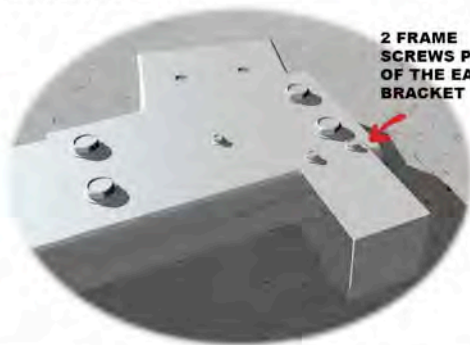

2 FRAME SCREWS PER SIDE OF THE EAVE PURLIN BRACKET

DOUBLE COLUMN EAVE PURLIN BRACKET CONNECTION

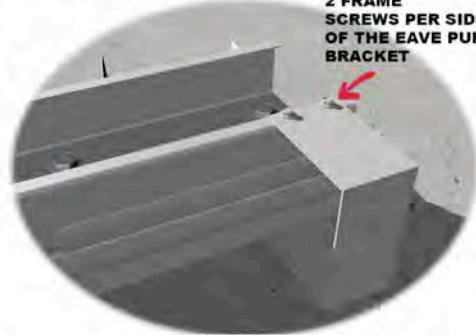

2 FRAME SCREWS PER SIDE OF THE EAVE PURLIN BRACKET

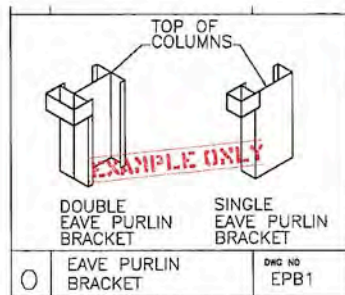

DETAIL - 1
mm FROM TOP OF COLUMN

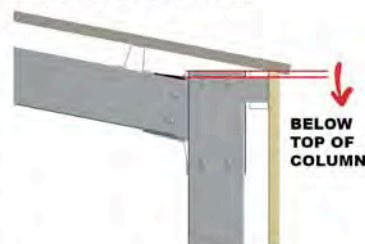

9. MAKING UP THE WALL FRAMES

EAVE PURLINS

Rotate the columns 90° to stand on their flange with the eave purlin bracket facing upwards down one side wall. The eave purlin is attached to the eave purlin bracket using 1 framing screw on each end. The size of the eave purlin is dependant on the size of the structure, and may not be identical to the other C Sections, Z Sections or Tophats.

Note: If C Sections are used as eave purlins, they are 'butt joined' together (not overlapped) on an eave purlin bracket.

ATTACHING EAVE PURLINS

EAVE PURLIN CONNECTION AT END WALL COLUMN

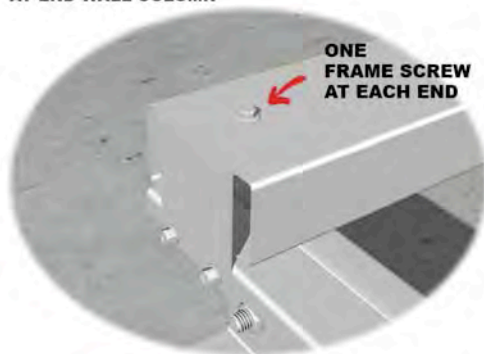

EAVE PURLIN CONNECTION BUTT JOINED AT INTERMEDIATE COLUMN

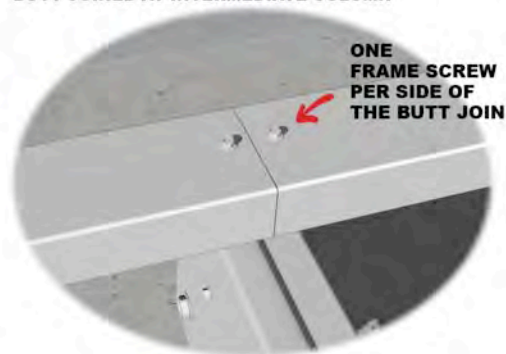

SIDE WALL GIRTS

Mark side wall girt spacings on the columns. First row of girts is 200mm from floor level and the rest of the girts are to be equally spaced (as per engineering plans). The end of the girts will be flush with the outside edge of the end columns (i.e. overall length of the slab). Use 1 frame screw at each gable end wall column to hold the girts in place.

SIDE WALL GIRT SPACING

MARK SIDE WALL SPACING ON COLUMNS AS PER THE MEMBER & MATERIAL SCHEDULE INCLUDED IN YOUR ENGINEERING PLANS



5	ENDWALL RAFTERS	C20019
6	ENDWALL COLUMNS	C20016
7	ENDWALL VERTICAL WALL BRACKET	Single C20019
8	ANCHOR BOLTS (# PER DETS.)	Sleeve Anchor 16.0x110 Z/Y
9	EAVE PURLIN	C10010
10	TYP. ROOF PURLIN SIZE	Tophat 64 x 1.0
11	MAIN BLDG. PURLIN SPACING	1.13 m.
12	MAIN BLDG. PURLIN LENGTH	4.4 m. (0.4m Overlap)
13	TYP. SIDEWALL GIRT SIZE	Tophat 64 x 1.0
14	MAIN BLDG. SIDEWALL GIRT SPACING	1.2 m.
15	MAIN BLDG. SIDEWALL GIRT LENGTH	4.4 m. (0.4m Overlap)
16	TYP. ENDWALL GIRT SIZE	Tophat 64 x 1.0

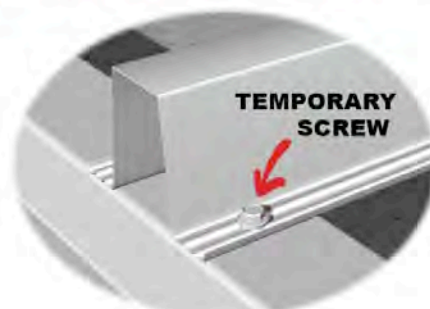

SQUARING THE FRAME

Use a string line to make sure the bottoms of the columns are in a straight line.

Measure the diagonals of the wall frame ensuring that both measurements are equal. If not, adjust the wall until the measurements are equal, making sure the base of the columns remain straight to the string line.

SQUARING THE FRAME

MEASURE BOTTOM EDGE AND DIAGONALS WITH A STRING LINE

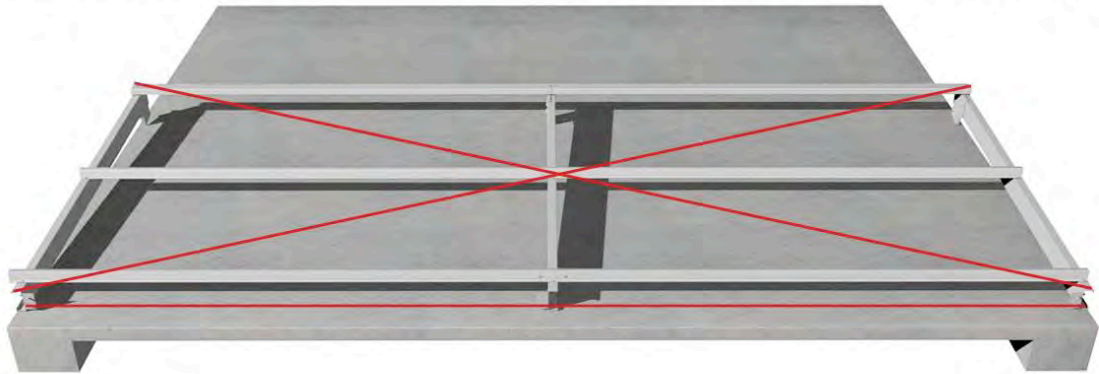

FINISHING THE FRAME

Once the frame is completely square, finish fixing the side girts and eave purlins to the columns (as per engineering plans). If cross bracing or fly bracing is required in the side wall, fix into position (as per engineering plans) prior to cladding walls.

FIXING OFF SIDE WALL GIRTS

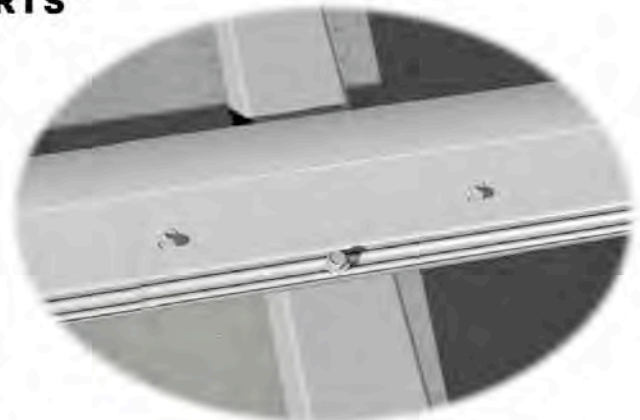
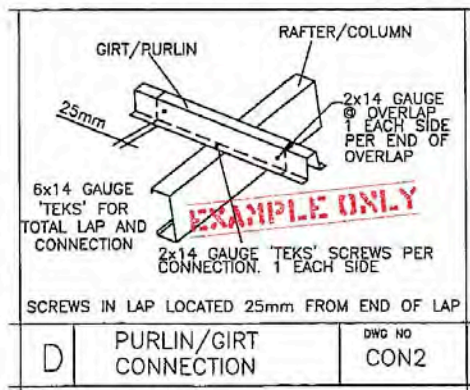

**Installation of SIDE WALL ROLLER DOOR JAMBS & HEADERS
 should occur at this point – Refer to
 Chapter 44 INSTALLATION OF SIDE ROLLER DOOR**

10. SIDE WALL SHEETING

Lay sheeting on wall girts making sure that the female rib of the cladding is facing away from prevailing weather. Make sheeting flush with the top of the eave purlin ensuring that the sheets will overlap the foundation of the building to prevent water entering the building. Using the required number of wall screws (as per engineering plans), one at a time, fix the wall sheets, using a straight edge/chalk line to ensure screws are placed in a straight line. Cut the last wall sheet flush to the end of the wall girts.

Note: When zinc and/or Colorbond sheets are cut, it is important to sweep the edge of the metal with a soft haired brush to remove the 'swarf'. Should any 'swarf' remain on the product after cutting it may cause rusting and this may void the warranty.

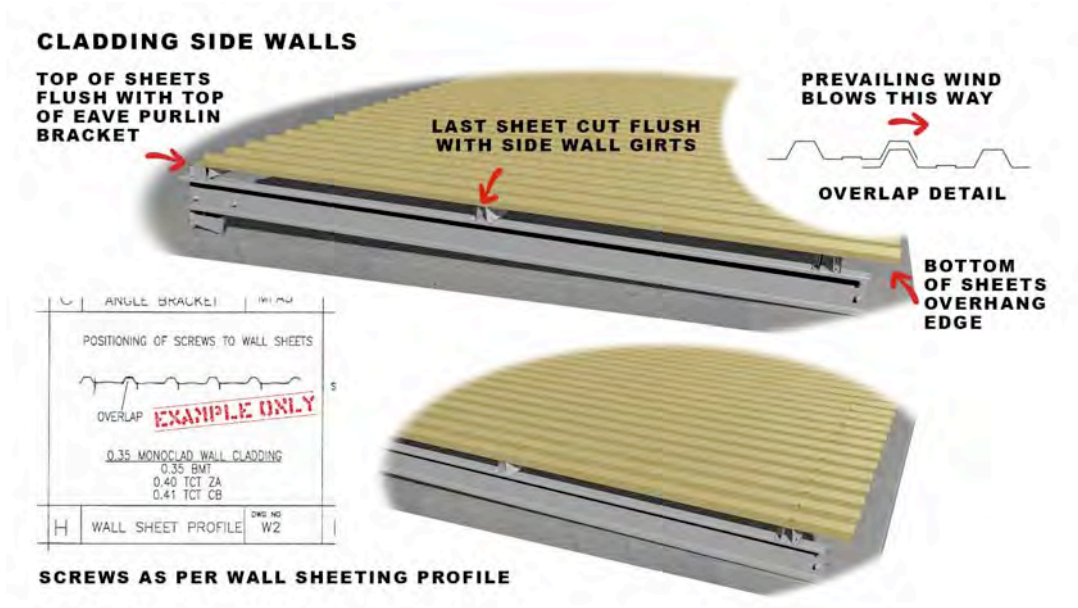

If an opening (Personal Access Door, Roller Door, Glass Sliding Door or Window) is to be installed on the side wall allow the standard overlap on wall cladding and leave out the wall sheeting where the door or window is to be positioned until all other sheets are screwed into position. Install the sheets above the door or window once the height of the door has been established. Refer to the relevant chapter(s) for more details:

Chapter 27 INSTALLATION OF SIDE WALL ROLLER DOOR

Chapter 29 INSTALLATION OF SIDE WALL PERSONAL ACCESS DOOR

Chapter 31 INSTALLATION OF SIDE WALL WINDOW

Chapter 33 INSTALLATION OF SIDE WALL GLASS SLIDING DOOR

Note: Do not fit a Door or Window until walls are clad and standing.

Note: On side walls, the sheets above the window or door will need to be measured and cut to the required length.

SIDE WALL OPENINGS



11. GUTTERING

First peel the protective plastic back off the gutters and stop ends.

GUTTER LENGTH

Overall length of the gutters is the overall length of the building from outside to outside edge of Gable End Wall sheets. To calculate this distance, add 2 x the height of the rib of the cladding to the length of the building as shown in the diagram below. Overlap should be joined using Silicone & Pop Rivets.

CALCULATING GUTTER LENGTH



LENGTH OF BUILDING
eg: 7m
7000mm

PLUS

2 x HEIGHT OF RIB OF CLADDING
eg: 2 x 32mm = 64mm

= TOTAL GUTTER LENGTH
eg: 7000mm + 64mm = 7064mm

SEAL OVERLAP WITH SILICONE AND POP RIVETS

STOP ENDS & DOWNPIPE NOZZLES

Fit gutter stop ends to the gutter and silicone, drill and rivet into position. Position the downpipe nozzles onto the underside of each gutter. Trace the inside of the nozzle using a permanent marker. Cut these holes in the bottom of the gutters using tin snips, then silicone, drill & rivet nozzles into position. Applying silicone to the downpipe nozzles and end caps helps to avoid any leakage.

Note: Cut Steel is extremely sharp. Use caution during this stage of construction.

STOP ENDS & DOWNPIPE NOZZLES

TRACE INSIDE OF DOWNPIPE NOZZLE ONTO GUTTER AND CUT OUT USING TIN SNIPS



ATTACH STOP ENDS AND DOWNPIPE NOZZLE WITH SILICONE & RIVETS

ATTACHING GUTTER BRACKETS & GUTTER

Count the number of brackets supplied per side of building and space brackets evenly. Gutter Brackets are to be spaced at a maximum of 1m intervals. Mark a chalk line starting from the top of the wall cladding at one end, with a slight downward slope towards the downpipe end (minimum 3°). Following the marked line attach gutter bracket to ribs of wall sheets with pop rivets. Apply silicone to gutter joints prior to installing gutter. Clip gutter onto gutter brackets ensuring gutters overhang Gable End Walls by a thickness of wall cladding (see calculating gutter length on previous page for details). Fold Gutter Bracket tags down onto the Gutter to hold it into position.

ATTACHING GUTTER BRACKETS & GUTTER



MARK A CHALK LINE WITH A SLIGHT DOWNWARD SLOPE TOWARDS DOWNPIPE END

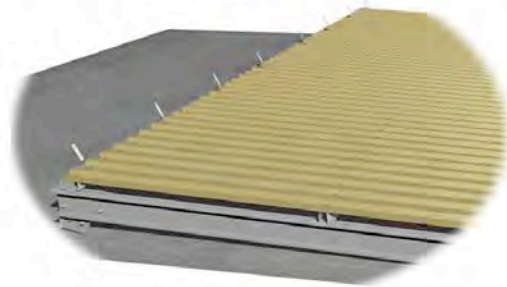

DISTRIBUTE HALF OF THE GUTTER BRACKETS EVENLY DOWN EACH SIDE WALL

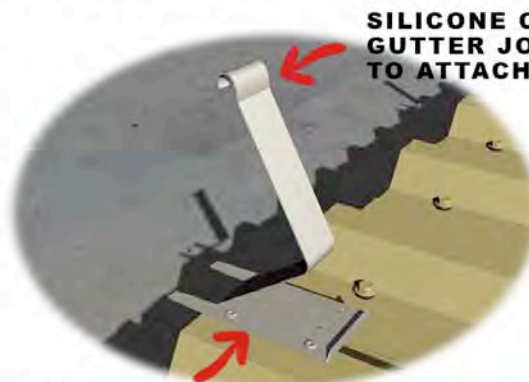

ATTACH BRACKETS TO CLADDING WITH POP RIVETS

SILICONE ON GUTTER JOINT TO ATTACH GUTTER

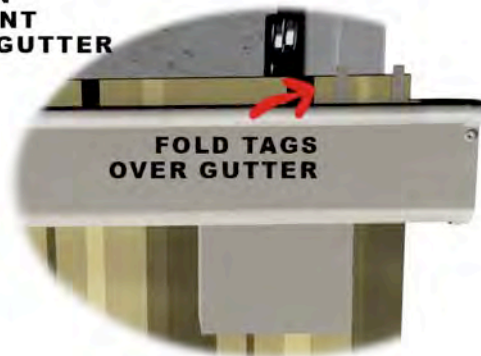

FOLD TAGS OVER GUTTER

12. OTHER SIDE WALL

REPEAT STEPS IN CHAPTERS 10 - 12 TO ASSEMBLE THE OPPOSITE SIDE WALL

Note: On smaller buildings where space is limited on the foundation, only one wall at a time can be built due to the lack of space. In this case, stand one wall, temporarily brace it and repeat steps 7-12 to assemble opposite side wall.

13. STANDING WALLS

Note: Do not attempt to stand walls on windy days

Secure rope ties into the ground with stakes then tie off onto frame. Make sure you have removed the string line from the bottom of the wall. With the assistance of other installers, (taking into consideration OH&S guidelines on lifting heavy weights) lift one side wall into position ensuring the end columns are flush with the ends of the foundation. Position the inside edge of the columns to the chalk line previously marked on the foundation. Brace and prop both sides of the wall, using timber or ropes tied securely around stakes driven into the ground.

Note: When propping under gutter, it is recommended that soft cloth or similar be tied around the end of props to avoid marking the gutter.

ONE WALL STANDING



WHEN PROPPING THE EXTERIOR OF STANDING WALLS BE SURE TO USE SOFT CLOTH AS A BUFFER TO PREVENT MARKING OF GUTTER AND WALL SHEETS

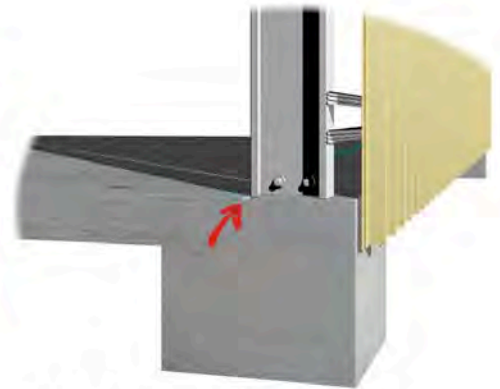

PLACE COLUMNS FLUSH WITH CHALK LINE PREVIOUSLY MARKED

Drill holes through base cleats on each column and secure with appropriate anchor bolt (as per engineering plans). Ensure that all holes are clean before placing masonry anchors. Check that all anchors are tightened down sufficiently and check columns are plumb using a spirit level. Re-adjust props if necessary.

BASE CLEAT CONNECTION

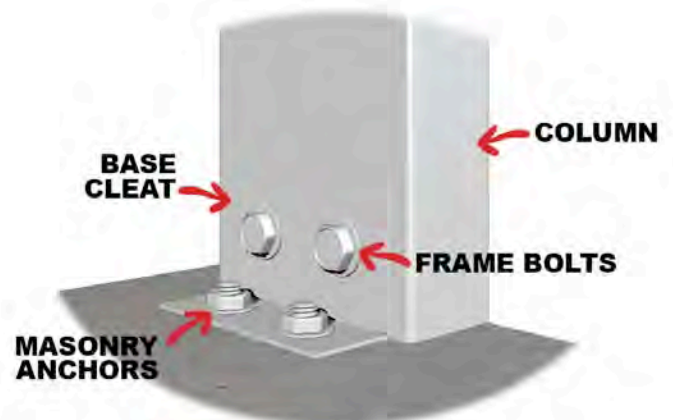
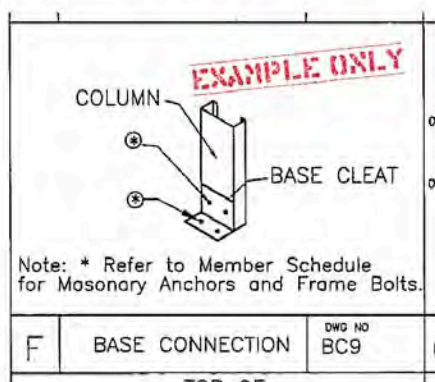

REPEAT THIS PROCESS FOR THE OPPOSITE WALL

BOTH SIDE WALLS STANDING



14. INSTALLING GABLE END WALL RAFTER

Starting at the back wall of the building, carefully lift the back rafter (previously made up in Chapter 7) and fit onto the haunch brackets. Using quick release clamps, clamp the rafters to the haunch brackets. The centre of the rafter should be supported temporarily until the Gable End Wall mullions are in place to stop the rafters rotating on the haunch brackets. If no Gable End Wall mullion is required the rafters must be temporarily supported until all roof purlins are in place. 2 Frame Screws are put in place to hold portals in location. Check the columns are plumb and adjust props if required. Then fix off connection completely according to engineering plans. Make sure to tighten all screws & bolts.

GABLE END WALL RAFTER IN PLACE

CLAMP & PROP THE CENTRE OF THE RAFTER UNTIL GABLE END WALL MULLIONS ARE INSTALLED

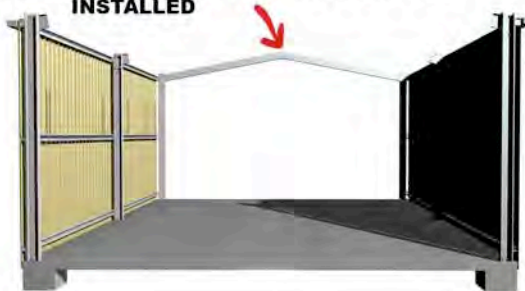

TEMPORARY SCREWS HOLD PORTALS IN LOCATION



FULLY FIXED HAUNCH BRACKET

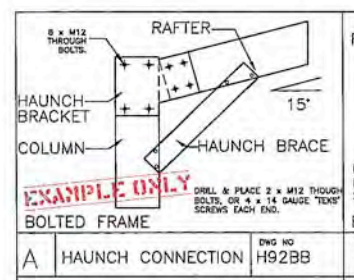

15. INSTALLING GABLE END WALL FRAMING (IF REQUIRED – SEE ENGINEERING PLANS)

GABLE END WALL MULLION

Fix the base cleat to the bottom of the Gable End Wall mullion. Attach the mullion fixing angle bracket to the top of the Gable End Wall mullion on the web face. Gable End Wall mullions are to be spaced (as per engineering plans), and are offset by the size of the end girt from the edge of the slab (see diagram below).

Fit Gable End Wall mullions so that the web of the C Section is perpendicular to the Gable End Wall girt, with the web face of the mullion facing towards the prominent opening of the building. Stand the Gable End Wall mullions into position. Drill holes through base cleats on each mullion and secure with appropriate anchor bolt (as per engineering plans). Ensure that all holes are clean before placing masonry anchors. Check that all anchors are tightened down sufficiently. Check mullions are plumb using a spirit level on the web face. Attach the mullion fixing angle bracket to the rafter (as per engineering plans). Check mullions are plumb using a spirit level on the flange side and securely prop mullion into position.

Note: In many cases Apex bracket bolts may have to be adjusted to fit the centre Gable End Wall mullion into place. Additional bolts may also be required. For further information check the Mullion Fixing Angle Bracket Detail in your Engineering Plans.

GABLE END WALL MULLION

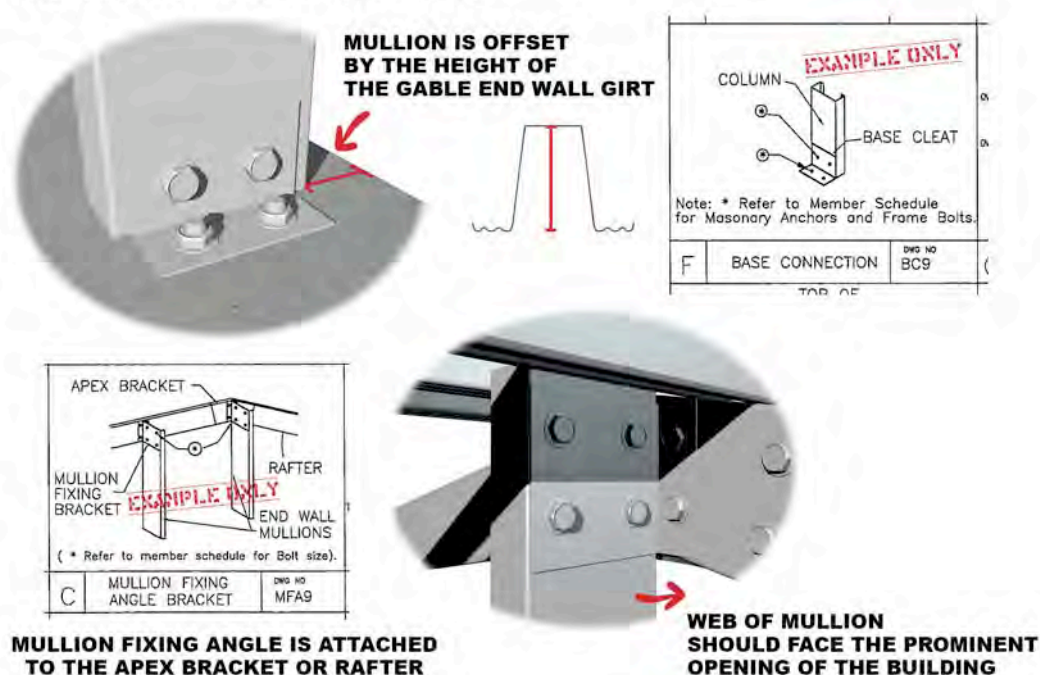

16. INSTALLING REMAINING RAFTERS

Fit remaining rafters as in Chapter 15 Installing End Rafter. As each intermediate rafter is fitted at least one roof purlin (more on larger buildings) must be fixed into position securing all rafters back to the Gable End Wall. Make sure to plumb each portal frame before tightening bolts.

Note: Care must be taken not to allow rafters to rotate around haunch brackets. Use propping or extra roof purlins to achieve this.

2ND RAFTER IN PLACE ROOF PURLIN FIXED TO SECURE RAFTERS IN PLACE (END TO BE PROPPED TEMPORARILY)



17. FIXING ROOF PURLINS

Lift previously made up roof purlins (see Chapter 7) onto the rafters aligning them with temporary screws that are in place (see Chapter 8). Roof purlins end flush with the outer face of the rafters on the Gable End Wall. Attach the roof purlins on the previously marked rafters with one screw per connection initially. Ensure that both Gable End Walls and all intermediate rafters are plumb before the roof purlins are fully secured (as per engineering plans). Ensure that the spacing between the rafters is the same as the spacing between the columns. If roof bracing is required, fix into position (as per engineering plans) prior to sheeting the roof.

ALL RAFTERS AND ROOF PURLINS IN PLACE

ROOF PURLINS END FLUSH WITH OUTER FACE OF RAFTERS

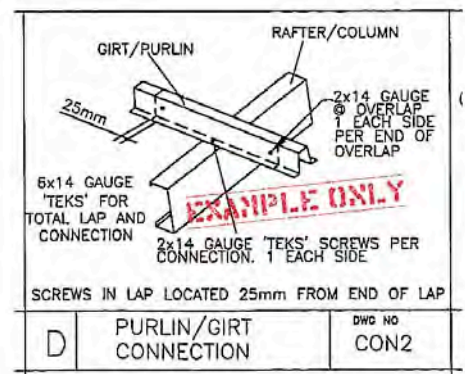

FIX OFF AS PER ENGINEERING PLANS

18. FIXING KNEE & APEX BRACES

(IF REQUIRED – SEE ENGINEERING PLANS)

Fit any knee or apex braces as supplied. Refer to engineering plans for size, fitting location and fixing detail. On back-to-back frames it is required to “notch” the ends of apex and knee braces to fit in-between back-to-back frames. This is done using an angle grinder (see diagram below). This can also be done on single framed buildings for aesthetics.

Note: Bracing may not be required on all portal frames. Check Engineering Plans for details.

Note: Do not fit knee or apex braces to the lips of columns or rafters.

KNEE & APEX BRACING

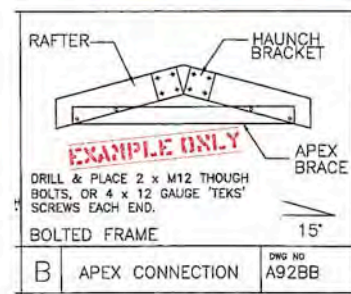
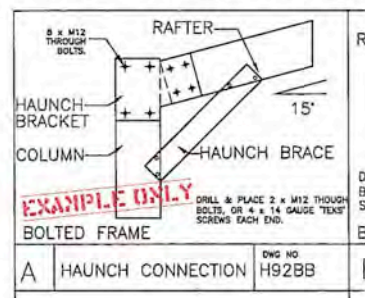

NOTCHED APEX & KNEE BRACING

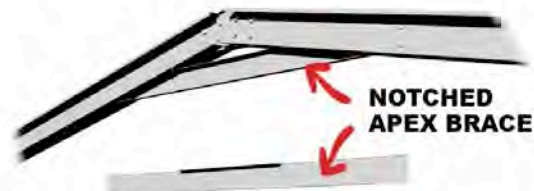

ON BACK TO BACK FRAMES IT IS REQUIRED TO NOTCH THE ENDS OF APEX & KNEE BRACES TO FIT IN BETWEEN BACK TO BACK FRAMES

Installation of GABLE END WALL ROLLER DOOR JAMBS & HEADERS should occur at this point – Refer to Chapter 45 INSTALLATION OF GABLE END WALL ROLLER DOOR

19. GABLE END WALL GIRTS

Fix the Gable End Wall girt brackets to the inside flange face of the Gable End Wall columns as shown, spacings as per engineering plans. Attach the Gable End Wall girts to these brackets, overlapping the girts on the Gable End Wall mullion.

If Gable End Wall bracing is required fix into position (as per engineering plans) prior to cladding the wall.

ATTACHING GABLE END WALL GIRTS

12	MAIN BLDG. PURLIN LENGTH	4.4 m. (0.4m Overlap)
13	TYP. SIDEWALL GIRT SIZE	Tophat 64 x 1.0
14	MAIN BLDG. SIDEWALL GIRT SPACING	2.2 m.
15	MAIN BLDG. SIDEWALL GIRT LENGTH	4.4 m. (0.4m Overlap)
16	TYP. ENDWALL GIRT SIZE	Tophat 64 x 1.0
17	MAIN BLDG. ENDWALL GIRT SPACING	1.2 m.
18	MAIN BLDG. ENDWALL GIRT LENGTH	3.3 m. (0.48m Overlap)
19	FRAME SCREW FASTENERS	14-13x22 Hex C/S (SP HD 5/16" Hex Drive)

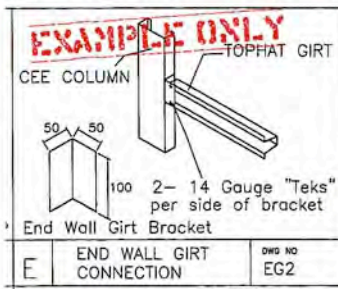

GABLE END WALL GIRTS IN PLACE

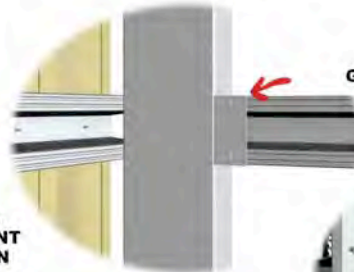

GABLE END WALL GIRT BRACKET ATTACHED TO COLUMN

INTERIOR VIEW



EXTERIOR VIEW



OVERLAP & ATTACHMENT TO MULLION

20. FLY BRACING

(IF REQUIRED – SEE ENGINEERING PLANS)

Please Check & Install Fly Bracing if required as per your engineering plans.

FLY BRACING

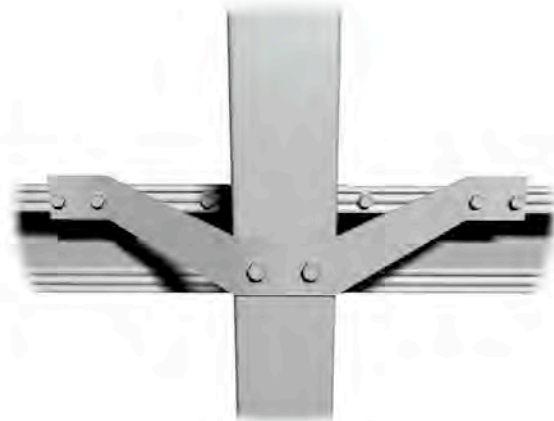
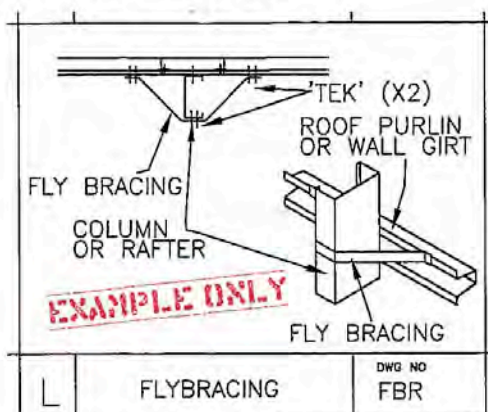

21. GABLE END WALL CLADDING

Sort wall sheet lengths from longest to shortest and lay out on a flat surface. Starting from one corner of the building, ensuring that the sheeting covers the side wall girts, begin sheeting the walls. Make sure that the female rib of the cladding is facing away from prevailing weather and that the bottom of the Gable End Wall cladding is level with the bottom of the side wall cladding.

Using the required number of wall screws (as per engineering plans), attach the Gable End Wall sheets one at a time. Use a straight edge/chalk line to ensure screws are placed in a straight line. Cut the last Gable End Wall sheet flush to the outside of the side wall girts. You may need to remove props from Gable End Walls to enable access for wall sheeting. Ensure walls remain level and stable when removing props.

Note: When zinc and/or Colorbond sheets are cut, it is important to sweep the edge of the metal with a soft haired brush to remove the 'swarf'. Should any 'swarf' remain on the product after cutting it may cause rusting and this may void the warranty.

ATTACHING GABLE END WALL SHEETS



Once all the sheets are in position, trim the tops of the Gable End Wall sheets flush with or slightly below the top of the roof purlins using an electric nibbler or tin snips. Screw the top of the Gable End Wall sheets to the top lip of the rafters.

ATTACHING GABLE END WALL SHEETS CONTINUED

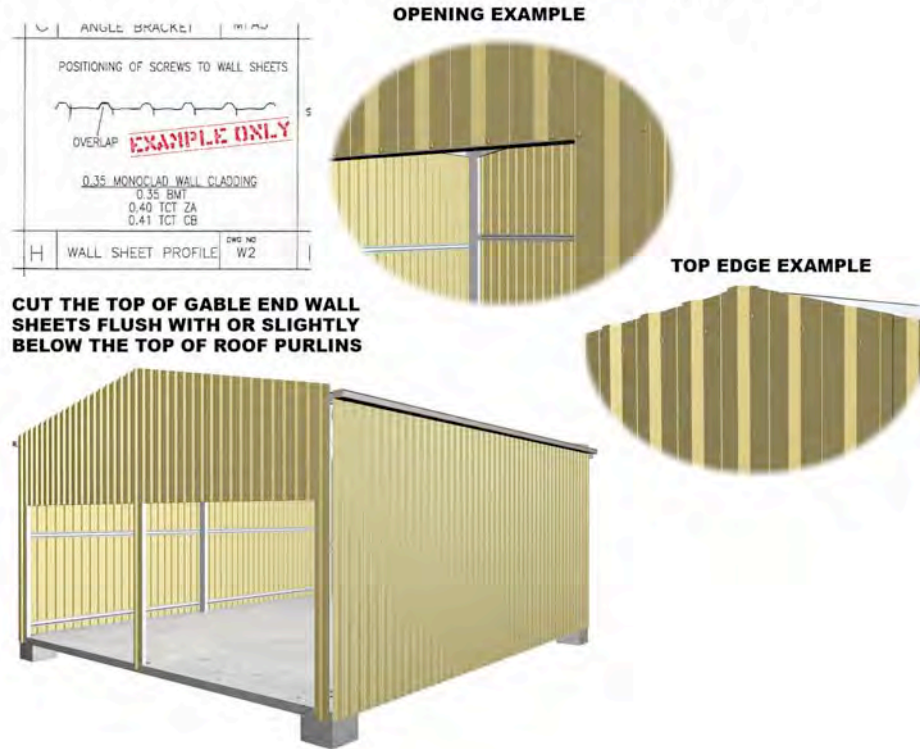

CUT THE TOP OF GABLE END WALL SHEETS FLUSH WITH OR SLIGHTLY BELOW THE TOP OF ROOF PURLINS

If an opening (Personal Access Door, Roller Door, Glass Sliding Door or Window) is to be installed on the Gable End Wall allow the standard overlap on wall cladding and leave out the wall sheeting where the door or window is to be positioned until all other sheets are screwed into position. Install the sheets above the door or window once the height of the door has been established. Refer to the relevant chapter(s) for more details:

Chapter 28 INSTALLATION OF GABLE END WALL ROLLER DOOR

Chapter 30 INSTALLATION OF GABLE END WALL PERSONAL ACCESS DOOR

Chapter 32 INSTALLATION OF GABLE END WALL WINDOW

Chapter 34 INSTALLATION OF GABLE END WALL GLASS SLIDING DOOR

Note: Do not fit a Door or Window until walls are clad and standing.

Note: On Gable End Walls, the sheets above the window or door will need to be measured and cut to the required length with the required angle to suit roof pitch.

GABLE END WALL OPENINGS



PA DOOR

ROLLER DOOR

GLASS SLIDING DOOR

LARGE AND

SMALL WINDOWS

22. CLADDING 2ND GABLE END WALL

Repeat Chapters 20-22 to clad the opposite Gable End Wall.

**Installation of PERSONAL ACCESS DOORS JAMBS
should occur at this point – Refer to
Chapter 46 or 47 INSTALLATION OF SIDE/END PERSONAL ACCESS DOOR**

23. ROOF SHEETING

ROOF BRACING & INSULATION

If cross bracing or fly bracing is required in the roof, fix into position (as per engineering plans) prior to cladding roof. If roof insulation is supplied, it must be installed prior to roof sheets being fixed into position. For more information, refer to the relevant supplier's recommended installation guidelines.

Note: Before fixing the roof sheeting into position, check that both side walls and Gable End Walls are straight and plumb by using a string line along the inside of the columns. Re-prop intermediate columns if necessary. This also keeps structure more rigid while working on the roof.

Turn up Sheeting along ridge line of roof cladding with pliers to protect from rain. This is called "Weathering" the sheets. Using the required number of roof screws (as per engineering plans), fix roof sheeting allowing approximately half the gutter width or 50mm (whichever is the least) overhang into the gutter. Ensure that the female rib of the cladding is facing away from prevailing weather. Check that roof sheets are parallel to the front edge of gutter at all times.

SKYLIGHTS

If skylights are supplied in your building ensure that all safety precautions are taken in accordance with local regulations. For more information, refer to the relevant supplier's recommended installation guidelines.

ROOF SHEETS

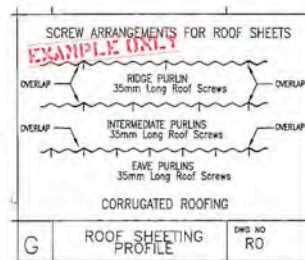
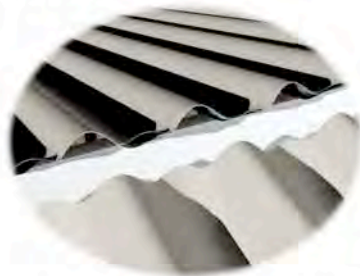

"WEATHERING" ROOF SHEETS

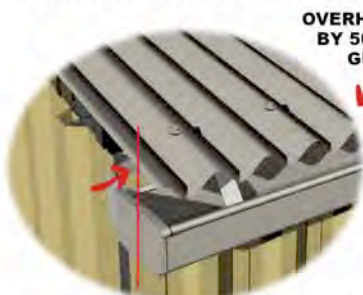

**OVERHANG GUTTER
BY 50mm OR HALF
GUTTER WIDTH**

**ROOF SHEETS CUT FLUSH
TO END OF GUTTERS**

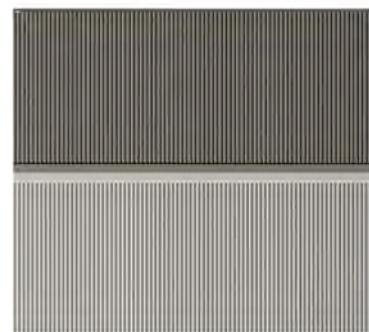

ROOF SHEETS IN PLACE

Note: When zinc and/or Colorbond sheets are cut, it is important to sweep the edge of the metal with a soft haired brush to remove the 'swarf'. Should any 'swarf' remain on the product after cutting it may cause rusting and this may void the warranty.

24. FLASHINGS

CORNER & OPENING FLASHINGS

Install all corner & opening flashings using pop rivets or wall screws. Spacings for the fixing of corner & opening flashings follow the Wall Sheeting Profile (as per engineering plans) where possible, and a screw or rivet 35mm from each end of the flashing. Ensure bottoms of all corner flashings on the building are flush to the bottom of wall sheets. Ensure Flashing is secure & watertight.

CORNER FLASHINGS

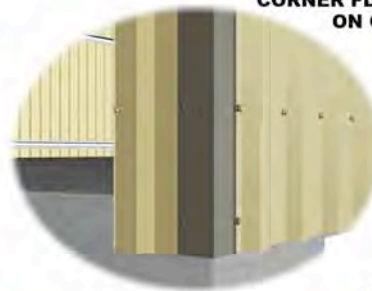
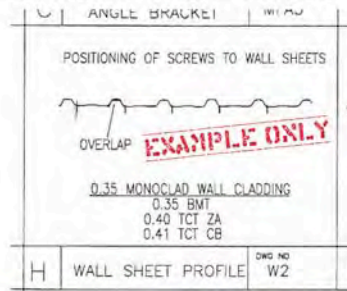

CORNER FLASHING ON CORNER

SCREWS AS PER WALL SHEETING PROFILE AND 35mm FROM EACH END



CORNER FLASHING ON ROLLER DOOR OPENING

RIDGE CAPPING

Install ridge capping, ensuring that the ends are flush to the outside of the Gable End Wall cladding. Joins must be facing away from prevailing weather. Run a bead of silicone where the ridge overlaps. Use the roof screws provided to attach ridge capping to the roof purlins on both sides of the flashing as per the Roof Sheeting Profile in your Engineering Plans.

RIDGE CAP

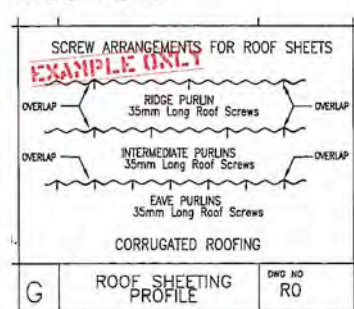

PREVAILING WIND BLOWS THIS WAY →

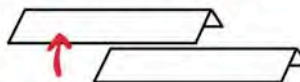

TOP LIP OF OVERLAP

ENSURE THE END OF THE RIDGE CAP IS FLUSH TO THE OUTSIDE OF GABLE END WALL CLADDING

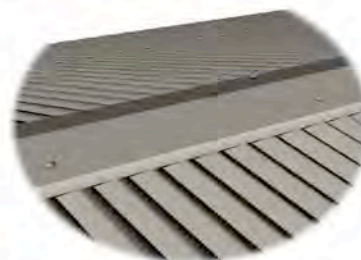
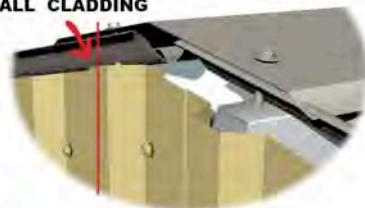

SCREWS AS PER ENGINEERING PLANS

BARGE CAPPING

Fix the first length of the barge capping in position using pop rivets or wall screws through the vertical leg of the flashing into the ribs of wall sheets. Then use roofing screws through the horizontal leg of the flashing into the roof purlins. Spacings are to follow the Roof Sheeting Profile (as per engineering plans). Ensure the top of the barge capping is in line with the centre of the ridge capping. Sit the second barge capping into position allowing a 10mm overlap over the centre of the ridge. Mark a vertical cutting line (plumb cut) down the face of the barge, using a spirit level and trim with tin snips to marked line. Fasten the second barge capping into position. Spacings are to follow the Roof Sheeting Profile (as per Engineering Plans). Plumb cut the ends of the barge level with the ends of the gutter. Fold down the 10mm overlap at the centre of the Horizontal leg of the second barge capping.

ATTACHING THE BARGE CAP FIRST SIDE INSTALLED



BARGE CAPPING COMPLETE

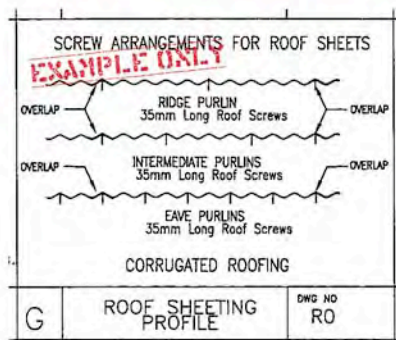

FOLD DOWN 10cm OVERLAP ON HORIZONTAL LEG



25. DOWNPIPES

Remove plastic coating from the downpipe. Fix downpipes to nozzle with pop rivets or wall screws. The larger end of the downpipe is attached to the nozzle allowing water to flow correctly. An ASTRAGAL (downpipe bracket) can be formed by trimming 50mm off the end of the downpipe and folding it into the desired shape. Alternately a screw can be fixed from the inside of the building through the bottom side wall girt into the downpipe.

ATTACHING THE DOWNPIPE

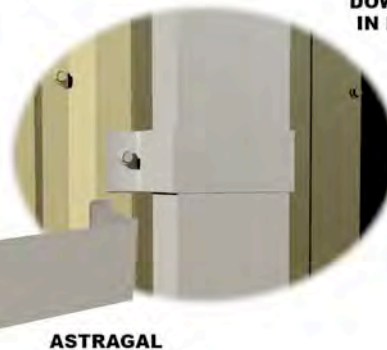
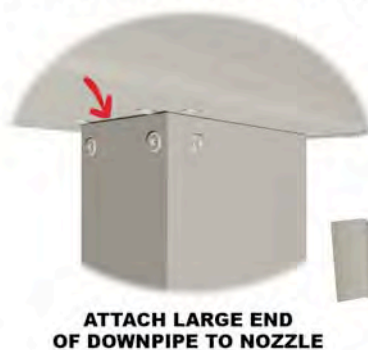

DOWNPIPE IN PLACE

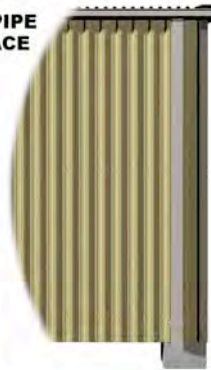

**Installation of PERSONAL ACCESS DOORS AND WINDOWS
should occur at this point – Refer to
Chapters 46 and 47 for PA Doors, and Chapters 48 and 49 for Windows.**

26. FINISHING

MAKE A FINAL CHECK OF THE STRUCTURE

ENSURE THAT ALL BASE CLEATS HAVE BEEN TIGHTENED DOWN FIRMLY

CHECK THAT THE ROOF AND WALL SCREWS ARE COMPLETE

**BRUSH THE COMPLETE STRUCTURE DOWN, INCLUDING THE ROOF WITH A
SOFT HAIR BROOM TO REMOVE ANY SWARF (metal dust and filings caused by
an angle grinder)**

**HOSE DOWN THE CONCRETE SLAB TO REMOVE ANY STEEL PARTICLES,
SCREWS AND RIVETS, WHICH MAY PUNCTURE A TYRE**

STAND BACK AND CONGRATULATE YOURSELF ON A JOB WELL DONE.

27. INSTALLATION OF SIDE WALL ROLLER DOOR

Please read and refer to the manufacturers recommended installation material supplied with the Roller Door(s) before proceeding with this Chapter.

Installation of SIDE ROLLER DOOR JAMBS & HEADERS should occur AFTER the side wall girts have been attached, and BEFORE Side Wall Sheeting.

Installation of SIDE WALL ROLLER DOOR & ASSOCIATED PARTS should occur AFTER the Flashings & Downpipes have been attached.

SIDE WALL ROLLER DOOR SIZE & LOCATION

Check your Engineering Plans and Bill of Materials for Side Roller Door size(s) & location(s). Side Wall Roller Doors can be located anywhere between two sidewall columns. If the door is to be offset to either the Left or Right of the Bay, allow a minimum of 100mm for the door brackets, from door opening to inside web face of the nearest column.

DOOR & WINDOW SIZE(S) & LOCATION(S)

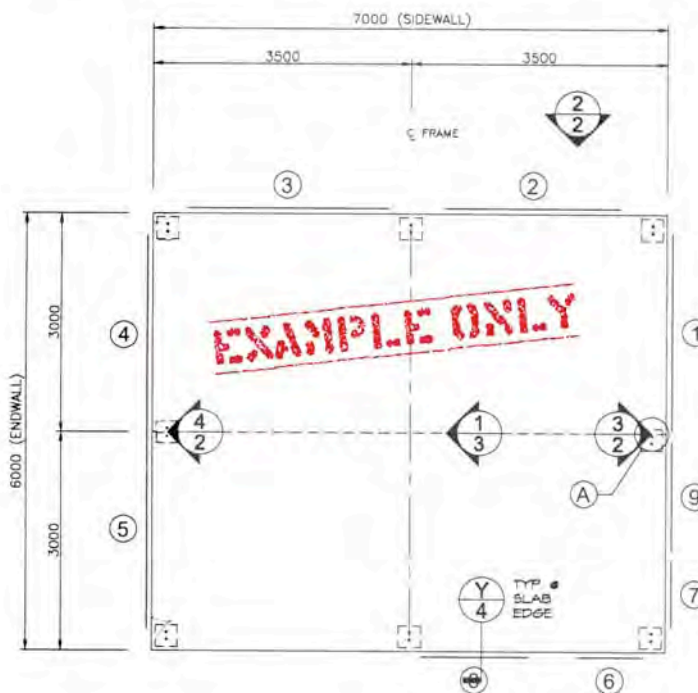

DOOR SCHEDULE					
DOOR	WIDTH	HEIGHT	OPENING TYPE	HEADER GIRT	OPENING JAMBS
①	2710	2200	2.20H X 2.77 CB *FIRMADOR R/D	SINGLE	
②	2390	2200	2.20H X 2.44 CB *FIRMADOR R/D	SINGLE	
③	2710	2500	2.50H X 2.77 CB *FIRMADOR R/D	SINGLE	
④	2710	2200	2.20H X 2.77 CB *FIRMADOR R/D	SINGLE	
⑤	2710	2200	2.20H X 2.77 CB *FIRMADOR R/D	SINGLE	
⑥	900	2100	PA DOOR 2 CB SPECIAL	SINGLE	
⑦	900	2100	PA DOOR 2 CB SPECIAL	SINGLE	
⑧	1490	900	WINDOW	SINGLE	
⑨	1490	900	WINDOW	SINGLE	

NOTES: 1) SEE SHEET 5 FOR DOOR OPENING FRAMING INFORMATION.
2) ALL DOOR SCHEDULE MEASUREMENTS ARE ACTUAL DOOR/WINDOW SIZE NOT OPENING SIZE.

THESE 2 SECTIONS OF YOUR ENGINEERING PLANS SHOW THE SIZE & LOCATION OF ALL OPENINGS

SIDE WALL ROLLER DOOR OPENING SIZE

Refer to the supplied manufacturers recommended installation material for instructions on how to calculate the OPENING SIZE for the door (generally smaller in width and height than the roller door itself). Once calculated, mark the opening width onto the slab for placement of Roller Door Jambs. Cut the wall girt(s) to allow for the width of the door opening.

SIDE WALL ROLLER DOOR JAMBS

If there is a side wall girt between the top of the door and the eave purlin then the jamb will suit this length.

IF THERE IS NO GIRT ABOVE THE OPENING, (i.e. between the top of door and eave purlin) then the length of the jamb will be to the eave purlin. The jamb is to be attached to the SIDE WALL GIRT or EAVE PURLIN, whichever comes first. Measure length of vertical opening from the slab to the top of the SIDE WALL GIRT or EAVE PURLIN to which the Side Wall Roller Door is to be attached. Side Wall Roller Door Jambs are to be trimmed to this exact length. Measure the height of the SIDEWALL GIRT or EAVE PURLIN and cut this amount out of the centre section of each Side Wall Roller Door Jamb as shown.

Fit L/H and R/H side door jambs and screw the two upright (uncut) legs to both sides of the SIDE WALL GIRT or EAVE PURLIN using Framing Screws.

SIDE WALL ROLLER DOOR JAMB CONNECTIONS

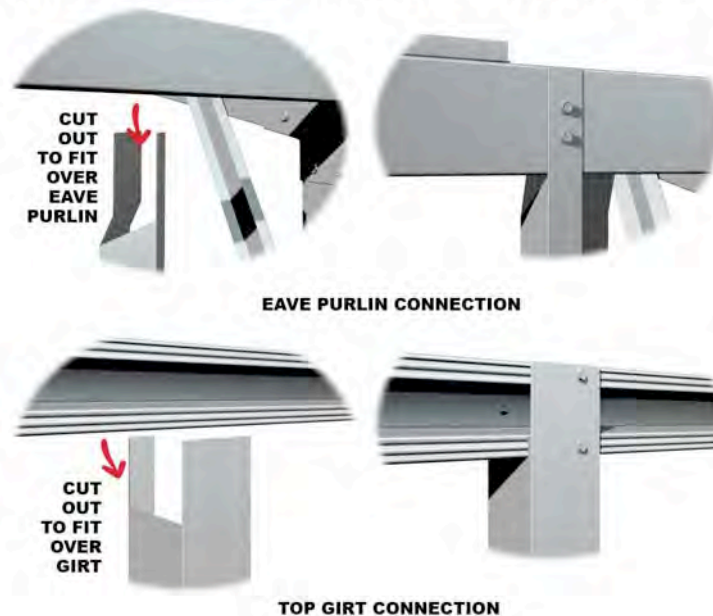

Ensure the jambs are plumb, then fix a base cleat to the bottom of each door jamb (with offset as per manufacturers installation material) and anchor bolt into position. Fix the door jambs at each intersection of girts which were cut off.

SIDE WALL ROLLER DOOR HEADER

Height of door header is equivalent to the height of the door opening required. Refer to the supplied manufacturers installation material for instructions on how to calculate the OPENING HEIGHT(s) for each Roller Door provided. Measure & mark the opening height for the Roller Door onto the Side Wall Roller Door Jambs. Fit the Roller Door Header (C Section) between the jambs using Gable End Wall girt brackets and Framing Screws. Complete the cladding around the door and trim to exact size.

SIDE WALL ROLLER DOOR CONNECTIONS



For more information on installing the Side Roller Door and all associated parts, refer to the relevant supplier's recommended installation guidelines.

SIDE WALL ROLLER DOOR



28. INSTALLATION OF GABLE END WALL ROLLER DOOR

Please read and refer to the manufacturers recommended installation material supplied with the Roller Door(s) before proceeding with this Chapter.

Installation of END ROLLER DOOR JAMBS & HEADERS should occur AFTER the Apex & Knee Braces have been attached, and BEFORE Gable End Wall Girts are attached.

Installation of GABLE END WALL ROLLER DOOR & ASSOCIATED PARTS should occur AFTER the Flashings & Downpipes have been attached.

GABLE END WALL ROLLER DOOR SIZE & LOCATION

Check your Engineering Plans and Bill of Materials for End Roller Door size(s) & location(s). Gable End Wall doors must be located as per engineering plans, as Gable End Wall door jambs are usually cut to required size. On Smaller Buildings Gable End Wall Columns may be used as Gable End Wall Roller Door Jambs.

DOOR & WINDOW SIZE(S) & LOCATION(S)

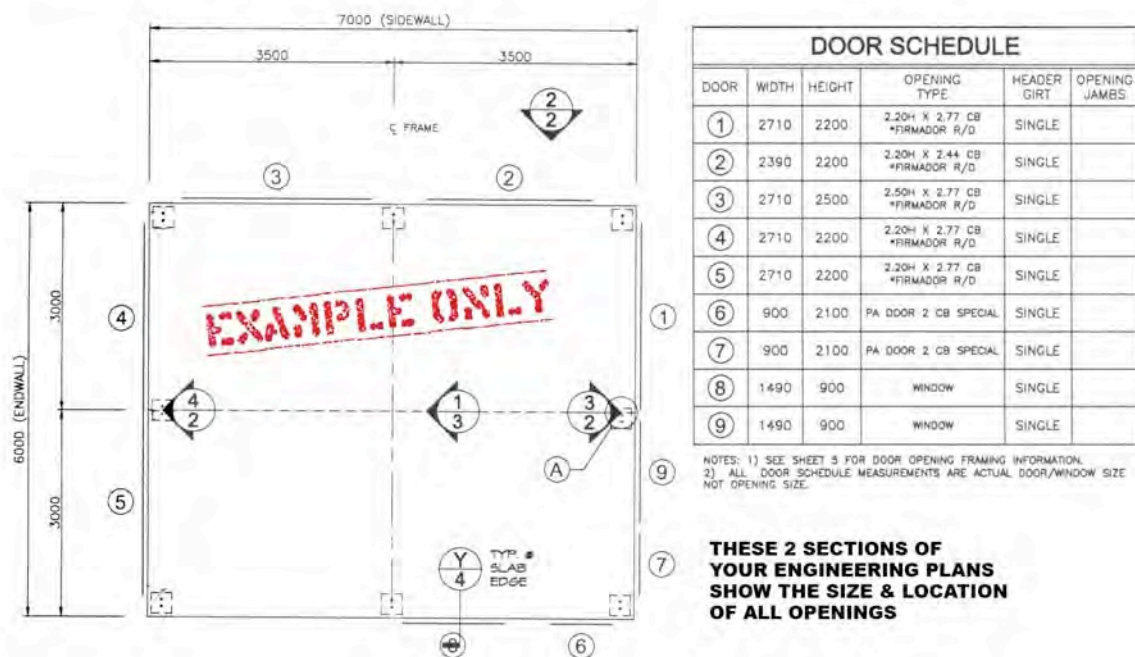

GABLE END WALL ROLLER DOOR OPENING SIZE

Refer to the supplied manufacturers recommended installation material for instructions on how to calculate the OPENING SIZE for the door (generally smaller in width and height than the roller door itself). Once calculated, mark the opening onto the slab for placement of Roller Door Jambs.

GABLE END WALL ROLLER DOOR JAMBS – C SECTIONS

Attach a Base Cleat Bracket to the bottom of each Gable End Wall Roller Door Jamb ensuring that it is offset to allow for the Roller Door Track (as per the supplied manufacturers installation material). Stand the Gable End Wall Roller Door Jamb vertically and align the inside edge of the post to the door opening width mark. Level the Gable End Wall Roller Door Jamb & mark the underside of the rafter onto it. Bring the Gable End Wall Roller Door Jamb down to the ground and cut it to the line just marked using a drop saw or angle grinder. Attach an Gable End Wall Mullion Fixing Angle Bracket to the freshly cut top end of the Gable End Wall Roller Door Jamb, allowing half of the bracket to sit on the post & the other half overhanging the end of the post as shown. Check Engineering Plans for number of fixings. Stand the Gable End Wall Roller Door Jamb back into position on the Opening Width mark & flush with the outside edge of the slab. Drill holes through the Base Cleat and Anchor Bolt the Gable End Wall Roller Door Jamb into position. Plumb the Gable End Wall Roller Door Jamb and fix to Rafter.

If a door is offset, or only one door is used, then additional Gable End Wall girts will need to be fitted between the Gable End Wall column and the door jamb. These are fitted using Gable End Wall girt brackets.

GABLE END WALL ROLLER DOOR JAMB CONNECTIONS

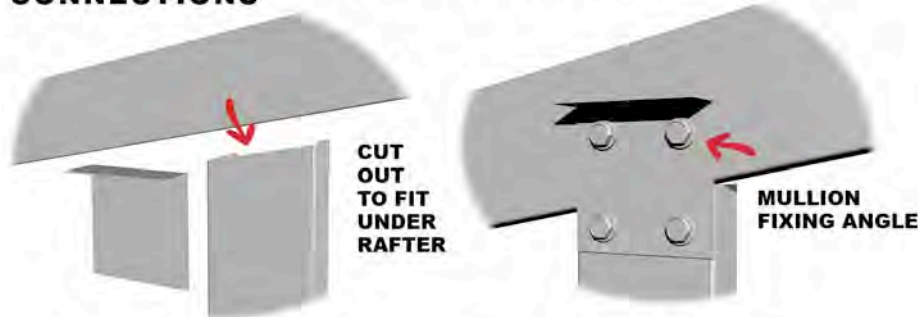

GABLE END WALL ROLLER DOOR JAMB TO RAFTER CONNECTION

GABLE END WALL ROLLER DOOR HEADER – C SECTION

The height of the door header is equivalent to the height of the door opening required. Refer to the supplied manufacturers installation material for instructions on how to calculate the OPENING HEIGHT for each Roller Door provided. Measure & mark the opening height for the Roller Door onto the Gable End Wall Roller Door Jambs. Fit the Roller Door Header (C Section) between the jambs using Gable End Wall girt brackets and Framing Screws. Complete the cladding around the door and trim to exact size.

GABLE END WALL ROLLER DOOR CONNECTIONS



BASE CONNECTION

GIRT CONNECTION

HEADER CONNECTION

For more information on installing the End Roller Door and all associated parts, refer to the relevant supplier's recommended installation guidelines.

GABLE END WALL ROLLER DOOR



29. INSTALLATION OF SIDE WALL PA DOOR

Please read and refer to the manufacturers recommended installation material supplied with the Personal Access Door(s) before proceeding with this Chapter.

Installation of SIDE WALL PERSONAL ACCESS DOOR JAMBS & HEADERS should occur AFTER the Cladding is completed and BEFORE Flashings are attached.

Installation of SIDE WALL PERSONAL ACCESS DOOR(S) should occur AFTER the Flashings & Downpipes have been attached.

SIDE WALL PERSONAL ACCESS DOOR SIZE & LOCATION

Check your Engineering Plans and Bill of Materials for Side Wall Personal Access Door size(s) & location(s). Side Wall Personal Access Doors can be located anywhere between two side wall columns as long as they do not conflict with bracing positions.

DOOR & WINDOW SIZE(S) & LOCATION(S)

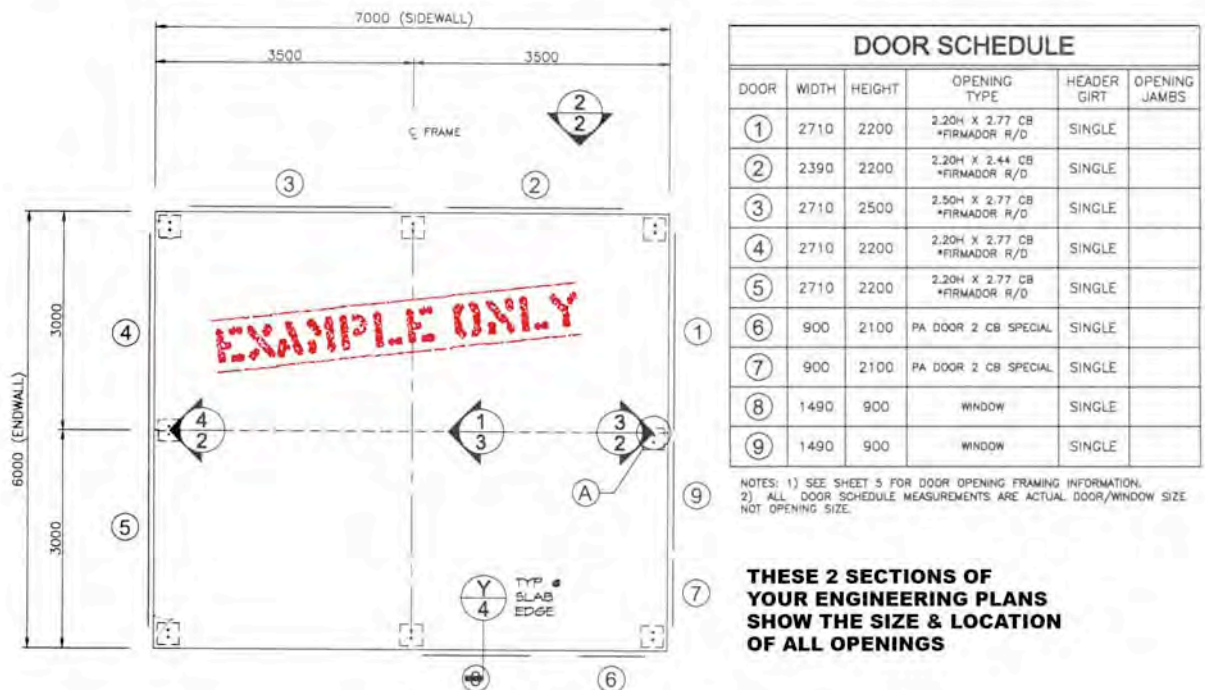

SIDE WALL PERSONAL ACCESS DOOR OPENING SIZE

Refer to the supplied manufacturers recommended installation material for instructions on how to calculate the OPENING SIZE for the door (generally exactly the same in width and height as the personal access door itself). Mark the opening in the desired location on the slab and side wall girts for placement of Personal Access Door Jambs. Once marked, cut the opening width from the side wall girts.

Prehung PA Doors Do not require Door Jambs or Headers to be installed. Refer to your Bill of Materials and the supplied manufacturers recommended installation material for details.

SIDE WALL PERSONAL ACCESS DOOR JAMBS ON BUILDINGS OVER 2.7m HIGH

PA Door Jambs are supplied at a maximum height of 2.7m. If your building is more than 2.7m high, an extra girt (PA Door Girt) must be fitted above the door height, leaving ample room to fit the Door Jamb Header. Attach the PA Door Girt to the columns on either side of the bay in which the PA Door is to be included. Attach the top ends of the PA Door Jambs to the PA DOOR GIRT.

SIDE WALL PA DOOR GIRT & JAMBS

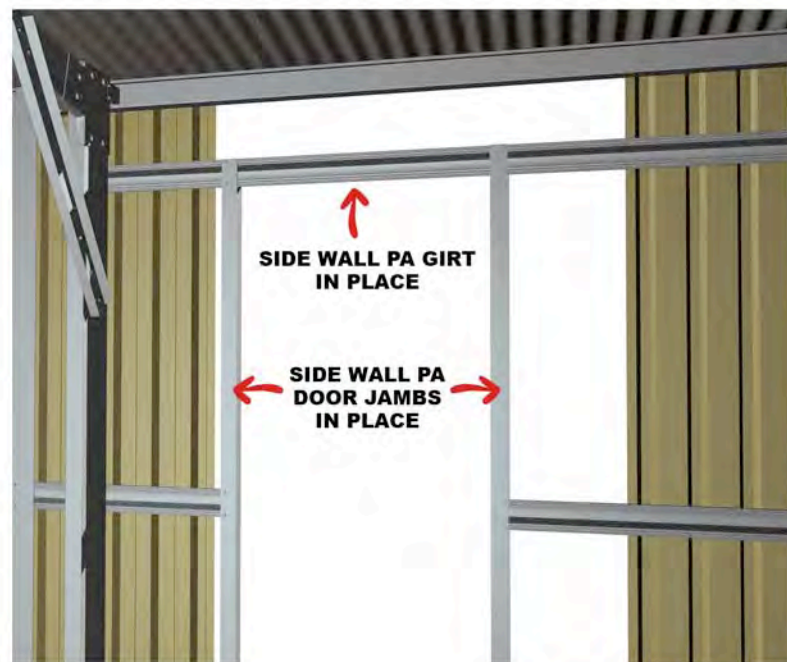

SIDE WALL PERSONAL ACCESS DOOR JAMBS ON BUILDINGS UNDER 2.7m HIGH

If there is a side wall girt between the top of the door and the eave purlin then the jamb will suit this length. IF THERE IS NO GIRT ABOVE THE OPENING, (i.e. between the top of door and eave purlin) then the length of the jamb will be to the eave purlin. The jamb is to be attached to the SIDE WALL GIRT or EAVE PURLIN, whichever comes first.

SIDE WALL PA DOOR JAMB CONNECTIONS



EAVE PURLIN CONNECTION



TOP GIRT CONNECTION

Measure length of vertical opening from the slab to the top of the SIDE WALL GIRT, PA DOOR GIRT or EAVE PURLIN to which the Side Wall Roller Door is to be attached. Side Wall Personal Access Door Jambs are to be trimmed to this exact length. Measure the height of the SIDEWALL GIRT, PA DOOR GIRT or EAVE PURLIN and cut this amount out of the centre section of each Side Wall Personal Access Door Jamb as shown. Fit L/H and R/H side door jambs around the side wall girts and screw the two upright (uncut) legs to both sides of the SIDE WALL GIRT, PA DOOR GIRT or EAVE PURLIN using Framing Screws.

Ensure the jambs are plumb, then fix a base cleat to the bottom of each door jamb and anchor bolt into position. Fix the door jambs at intersection of girt(s), which were cut off.

SIDE WALL PERSONAL ACCESS DOOR HEADER

A piece of the Personal Access Door Jamb is cut to the correct length to create the Personal Access Door Header. The total length of each Personal Access Door Header is calculated by adding 2 x Personal Access Door Jamb to the Opening Width of the Personal Access Door. The shape of the Left and Right Door Jambs is to be marked and cut out of the centre section of the Personal Access Door Header as shown. Height of personal access door header is equivalent to the height of the door itself. Measure & mark the opening height for the Personal Access Door onto the Side Wall Personal Access Door Jambs. Fit the Personal Access Door Header over the girts and between the jambs, and screw the 2 horizontal (uncut) legs on each end to both door jambs using Framing Screws. Complete the cladding around the door and trim to exact size.

SIDE WALL PA DOOR CONNECTIONS



BASE CONNECTION



GIRT CONNECTION



HEADER CONNECTION

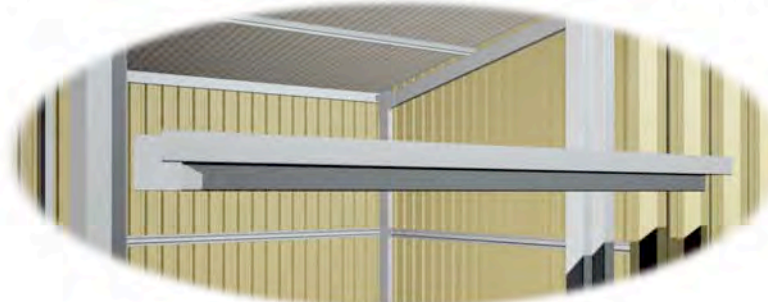

HEADER CUT OUT

For more information on installing the Personal Access Door and all associated parts, refer to the relevant supplier's recommended installation guidelines.

SIDE WALL PA DOOR



30. INSTALLATION OF GABLE END WALL PA DOOR

Please read and refer to the manufacturers recommended installation material supplied with the Personal Access Door(s) before proceeding with this Chapter.

Installation of GABLE END WALL PERSONAL ACCESS DOOR JAMBS & HEADERS should occur AFTER the Cladding is completed and BEFORE Flashings are attached.

Installation of GABLE END WALL PERSONAL ACCESS DOOR(S) should occur AFTER the Flashings & Downpipes have been attached.

GABLE END WALL PERSONAL ACCESS DOOR SIZE & LOCATION

Check your Engineering Plans and Bill of Materials for Gable End Wall Personal Access Door size(s) & location(s).

DOOR & WINDOW SIZE(S) & LOCATION(S)

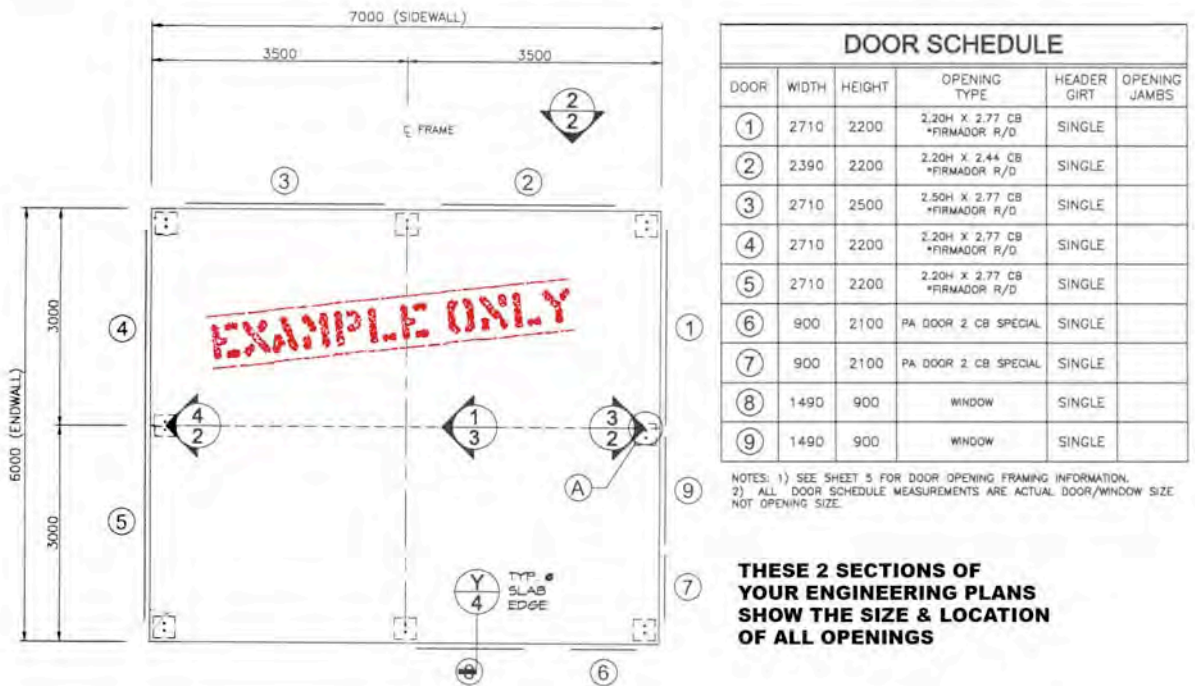

GABLE END WALL PERSONAL ACCESS DOOR OPENING SIZE

Refer to the supplied manufacturers recommended installation material for instructions on how to calculate the OPENING SIZE for the door (generally exactly the same in width and height as the personal access door itself). Mark the opening in the desired location on the slab and Gable End Wall girts for placement of Personal Access Door Jambs. Once marked, cut the opening width from the Gable End Wall girts.

Prehung PA Doors Do not require Door Jambs or Headers to be installed. Refer to your Bill of Materials and the supplied manufacturers recommended installation material for details.

GABLE END WALL PERSONAL ACCESS DOOR JAMBS ON BUILDINGS OVER 2.7m HIGH

PA Door Jambs are supplied at a maximum height of 2.7m. If your building is more than 2.7m high, an extra girt (PA Door Girt) must be fitted above the door height, leaving ample room to fit the Door Jamb Header. Attach the PA Door Girt to the columns on either side of the bay in which the PA Door is to be included. Attach the top ends of the PA Door Jambs to the PA DOOR GIRT.

END WALL PA DOOR GIRT & JAMBS

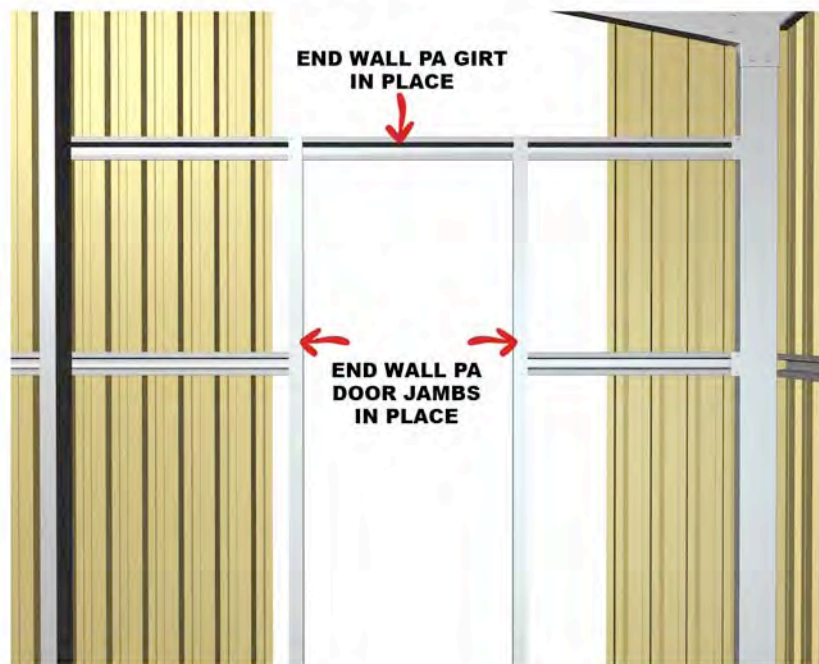

GABLE END WALL PERSONAL ACCESS DOOR JAMBS ON BUILDINGS UNDER 2.7m HIGH

If there is a Gable End Wall girt between the top of the door and the rafter then the jamb will suit this length. IF THERE IS NO GIRT ABOVE THE OPENING, (i.e. between the top of door and the rafter) then the length of the jamb will be to the rafter. The jamb is to be attached to the GABLE END WALL GIRT or RAFTER, whichever comes first.

GABLE END WALL PA DOOR JAMB CONNECTIONS

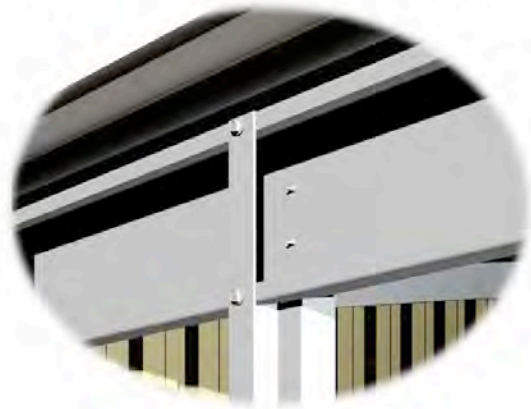
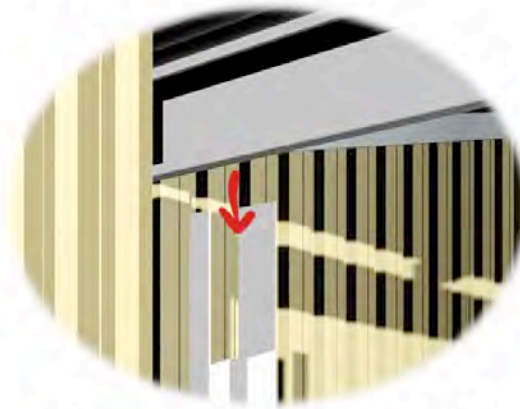

CUT OUT TO FIT OVER RAFTER
RAFTER CONNECTION



**CUT
OUT
TO FIT
OVER
GIRT**

TOP GIRT CONNECTION

Stand each Gable End Wall Personal Access Door Jamb vertically and align the lip of the jamb to the door opening width mark. Level the Gable End Wall Personal Access Door Jamb & mark the top of the GABLE END WALL GIRT, PA DOOR GIRT or RAFTER (*Diagonal Line*) onto it. Gable End Wall Personal Access Door Jambs are to be trimmed to this exact length. Measure the height of the GABLE END WALL GIRT, PA DOOR GIRT or RATER (*Diagonal Line*) and cut this amount out of two sides of the top end of each Gable End Wall Personal Access Door Jamb as shown. Fit L/H and R/H Gable End Wall personal access door jambs around the Gable End Wall girts, and screw the two upright (uncut) legs to both sides of the GABLE END WALL GIRT, PA DOOR GIRT or RAFTER using Framing Screws.

Plumb the jambs, then fix a base cleat to the bottom of each door jamb and anchor bolt into position. Fix the door jambs at intersection of girt(s), which were cut off.

GABLE END WALL PERSONAL ACCESS DOOR HEADER

A piece of the Personal Access Door Jamb is cut to the correct length to create the Personal Access Door Header. The total length of each Personal Access Door Header is calculated by adding 2 x Personal Access Door Jamb to the Opening Width of the Personal Access Door. The shape of the Left and Right Door Jambs is to be marked and cut out of the centre section of the Personal Access Door Header as shown. The height of the personal access door header is equivalent to the height of the door itself. Measure & mark the opening height for the Personal Access Door onto the Side Wall Personal Access Door Jambs. Fit the Personal Access Door Header over the girts and between the jambs and screw the 2 horizontal (uncut) legs on each end to both door jambs using Framing Screws. Complete the cladding around the door and trim to exact size.

GABLE END WALL PA DOOR CONNECTIONS



BASE CONNECTION

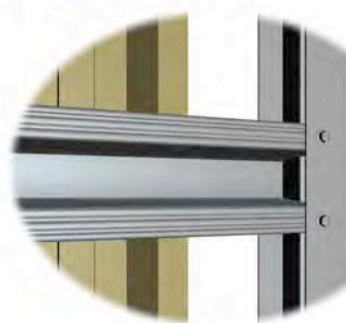

GIRT CONNECTION

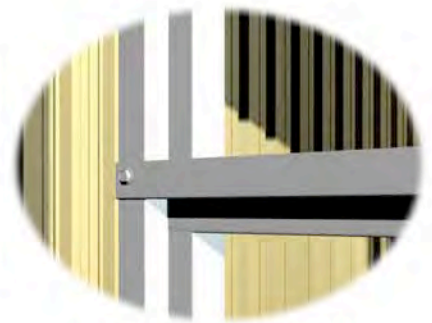

HEADER CONNECTION

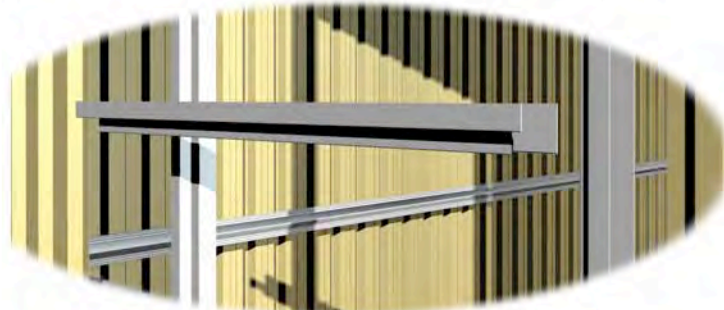

HEADER CUT OUT

For more information on installing the Personal Access Door and all associated parts, refer to the relevant supplier's recommended installation guidelines.

GABLE END WALL PA DOOR



31. INSTALLATION OF SIDE WALL WINDOW

Please read and refer to the manufacturers recommended installation material supplied with the Window(s) before proceeding with this Chapter.

Installation of SIDE WALL Window(s) should occur AFTER the Flashings & Downpipes have been attached.

SIDE WALL WINDOW SIZE & LOCATION

Check your Engineering Plans and Bill of Materials for Side Wall Window size(s) & location(s). Side Wall Windows can be located anywhere between two sidewall columns, providing they do not interfere with any bracing already installed in the side wall.

DOOR & WINDOW SIZE(S) & LOCATION(S)

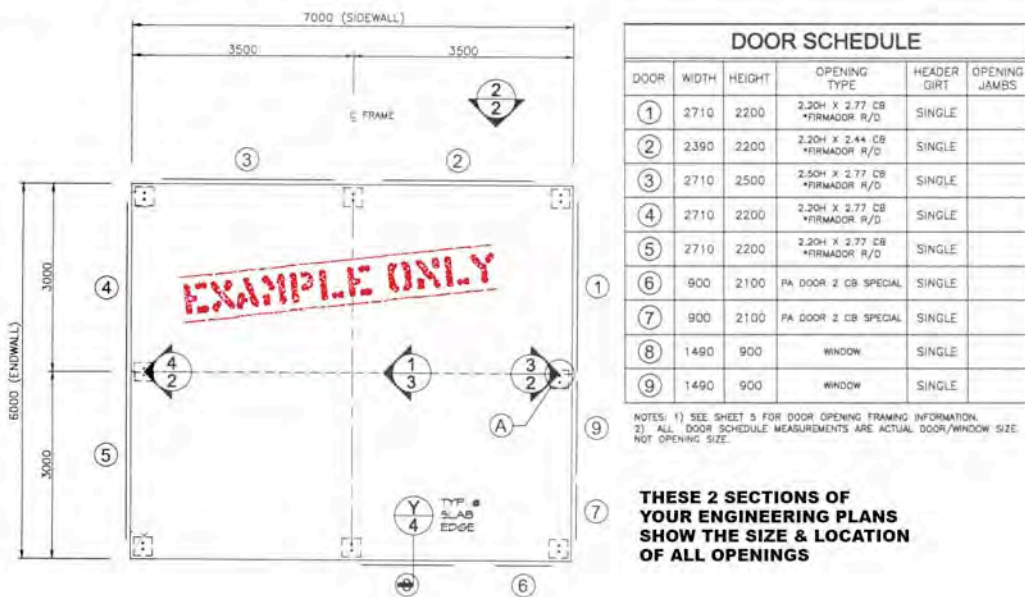

Windows have a REVEAL or FIN protruding from the centre of the window frame, which extends for approximately 30mm.

WINDOWS EXAMPLES

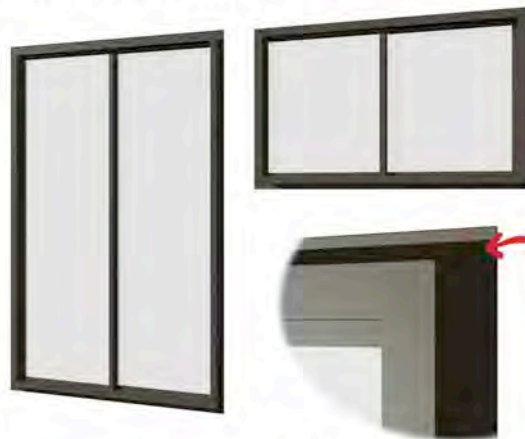

FIN FITS BETWEEN WALL SHEETS & GIRTS

If the HEIGHT of the Window is NOT GREATER than the spacing between the girts, the bottom fin of the window can be attached to a girt, and the top of the window is attached to EITHER the next girt above the window, the wall sheeting if close to a girt (within 200mm), OR directly to the eave purlin in particular instances.

If the HEIGHT of the Window is GREATER than the spacing between the girts, Side Roller Door Jambs are to be fitted so that the side fins may be attached to these jambs for rigidity. These jambs will only be required to fit between the girts above and below the window to form a frame.

SIDE WALL WINDOW OPENING SIZE

Refer to the supplied manufacturers recommended installation material for instructions on how to calculate the OPENING SIZE for the window (generally exactly the same in width and height as the window itself, with a slight clearance allowance so as not to break glass when installing into opening). Mark the opening in the desired location on the side wall girts for placement of Windows. Once marked, cut the opening width from the side wall girts and complete/trim side wall sheeting around either side of the opening.

SIDE WALL ROLLER DOOR JAMBS USED TO REINFORCE LARGE SIDE WALL WINDOWS

If there is a side wall girt between the bottom of the window and the slab then the jambs will start from this position. IF THERE IS NO GIRT BELOW THE OPENING (i.e. between the bottom of the window and the slab) then the starting point of the jambs will be to the slab. They start from the GIRT BELOW or SLAB, whichever is closest to the opening.

If there is a side wall girt between the top of the window and the eave purlin then the jambs will suit this length. IF THERE IS NO GIRT ABOVE THE OPENING, (i.e. between the top of window and eave purlin) then the length of the jambs will be to the eave purlin. They are to be attached to the SIDE WALL GIRT or EAVE PURLIN, whichever comes first.

Measure length of vertical opening from the SIDE WALL GIRT BELOW or SLAB to the top of the SIDE WALL GIRT ABOVE or EAVE PURLIN to which the Side Wall Roller Door Jambs are to be attached. Side Wall Roller Door Jambs are to be trimmed to this exact length. Measure the height of the SIDEWALL GIRT or EAVE PURLIN and cut this amount out of the centre section of the top end of each Side Wall Roller Door Jamb as shown.

SIDE WALL WINDOW DJ CONNECTIONS

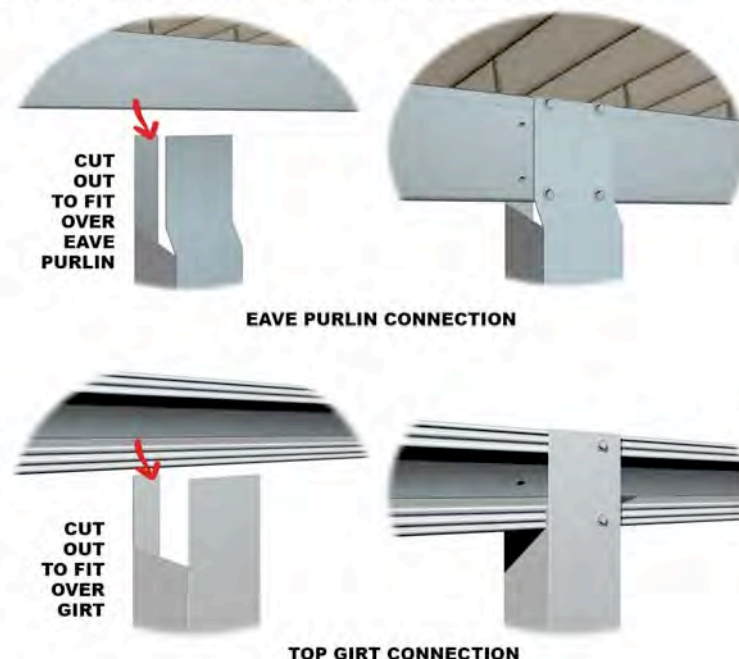

Measure the height of the SIDE WALL GIRT BELOW and cut this amount out of the centre section of the bottom end of each Side Wall Roller Door Jamb as shown.

SIDE WALL WINDOW DJ CONNECTIONS



BOTTOM GIRT CUT OUT



BOTTOM GIRT CONNECTION



INTERMEDIATE GIRT CONNECTION

If the Jamb sits on the slab then a Base Cleat Bracket is attached to the bottom of Each Side Wall Roller Door Jamb. Fit L/H and R/H side doorjamb and screw the two upright (uncut) legs to both sides of the SIDE WALL GIRT ABOVE or EAVE PURLIN using Framing Screws. Plumb the jambs, and screw the bottom upright (uncut) legs to the SIDE WALL GIRT BELOW. If the Jamb sits on the slab then drill holes in the base cleat and anchor bolt into position. Fix the door jambs at intersection of any girt(s) which were cut off. Complete the cladding around the window and trim to exact size.

SIDE WALL WINDOW DJ BASE CONNECTION



BASE CONNECTION

ATTACHING WINDOW TO OPENING

Position Window into Opening and fasten the protruding fin to the purlins, girts, door jambs and or wall sheets using Wall Screws or Pop Rivets.

For more information on installing the Side Wall Window(s) and all associated parts, refer to the relevant supplier's recommended installation guidelines.

SIDE WALL WINDOW

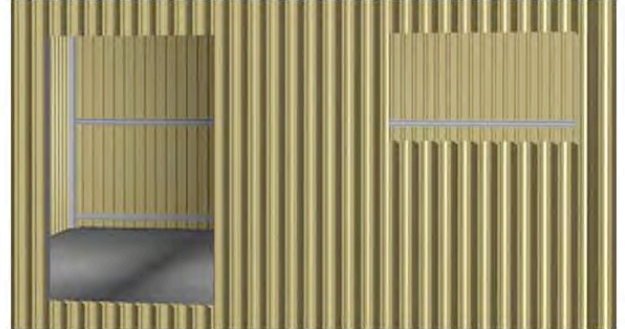

SIDE WALL WINDOW OPENINGS

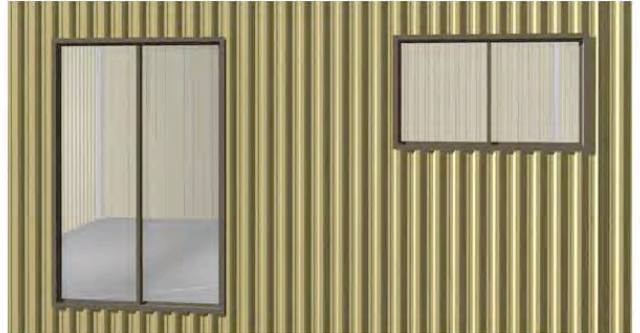

SIDE WALL WINDOWS IN PLACE

32. INSTALLATION OF GABLE END WALL WINDOW

Please read and refer to the manufacturers recommended installation material supplied with the Window(s) before proceeding with this Chapter.

Installation of GABLE END WALL Window(s) should occur AFTER the Flashings & Downpipes have been attached.

GABLE END WALL WINDOW SIZE & LOCATION

Check your Engineering Plans and Bill of Materials for Gable End Wall Window size(s) &

DOOR & WINDOW SIZE(S) & LOCATION(S)

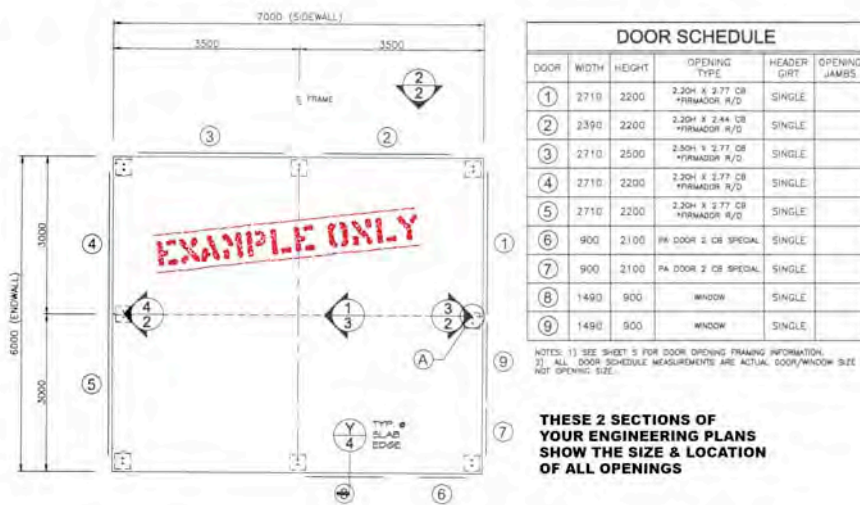

location(s).

Windows have a REVEAL or FIN protruding from the centre of the window frame, which extends for approximately 30mm.

WINDOWS EXAMPLES



FIN FITS BETWEEN WALL SHEETS & GIRTS

If the HEIGHT of the Window is NOT GREATER than the spacing between the girts, the bottom fin of the window can be attached to a girt, and the top of the window is attached to EITHER the next girt above the window, the wall sheeting if close to a girt (within 200mm), OR directly to the rafter in particular instances.

If the HEIGHT of the Window is GREATER than the spacing between the girts, Side Roller Door Jambs are to be fitted so that the side fins may be attached to these jambs for rigidity. These jambs will only be required to fit between the girts above and below the window to form a frame.

GABLE END WALL WINDOW OPENING SIZE

Refer to the supplied manufacturers recommended installation material for instructions on how to calculate the OPENING SIZE for the window (generally exactly the same in width and height as the window itself, with a slight clearance allowance so as not to break glass when installing into opening). Mark the opening in the desired location on the Gable End Wall girts for placement of Windows. Once marked, cut the opening width from the side wall girts and complete/trim side wall sheeting around either side of the opening.

GABLE END WALL ROLLER DOOR JAMBS USED TO REINFORCE LARGE GABLE END WALL WINDOWS

If there is an Gable End Wall girt between the bottom of the window and the slab then the jambs will start from this position. IF THERE IS NO GIRT BELOW THE OPENING (i.e. between the bottom of the window and the slab) then the starting point of the jambs will be to the slab. They start from the GIRT BELOW or SLAB, whichever is closest to the opening.

If there is an Gable End Wall girt between the top of the window and the rafter then the jambs will suit this length. IF THERE IS NO GIRT ABOVE THE OPENING, (i.e. between the top of window and rafter) then the length of the jambs will be to the rafter. They are to be attached to the GABLE END WALL GIRT or RAFTER, whichever comes first.

Measure length of vertical opening from the GABLE END WALL GIRT BELOW or SLAB to the top of the GABLE END WALL GIRT ABOVE or RAFTER (*Diagonal Line*) to which the Gable End Wall Roller Door Jambs are to be attached. Gable End Wall Roller Door Jambs are to be trimmed to this exact length. Measure the height of the GABLE END WALL GIRT or RAFTER (*Diagonal Line*) and cut this amount out of the centre section of the top end of each Side Wall Roller Door Jamb as shown.

GABLE END WALL WINDOW DJ CONNECTIONS

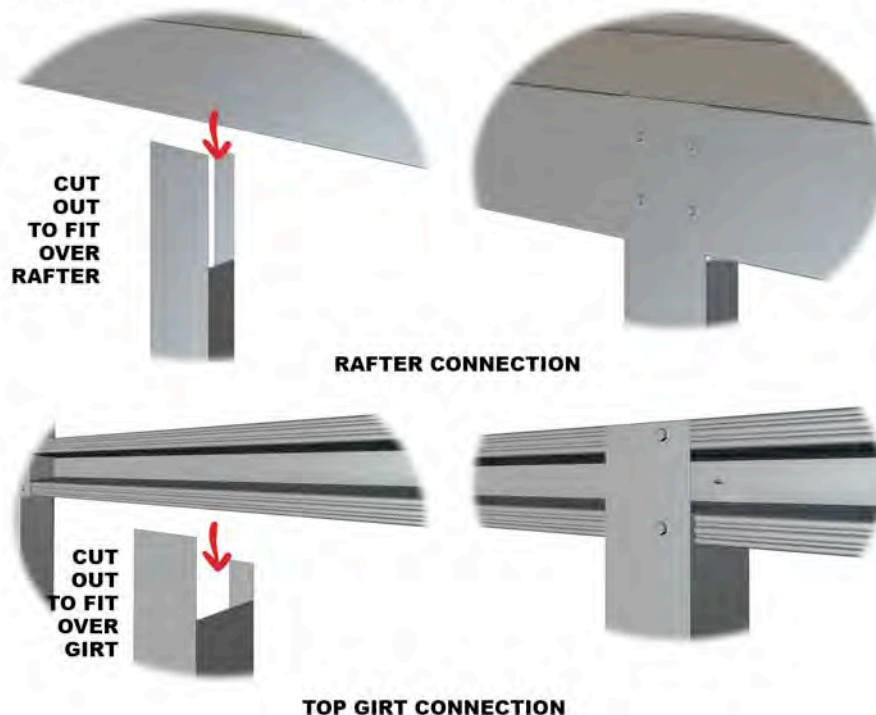

Measure the height of the GABLE END WALL GIRT BELOW and cut this amount out of the centre section of the bottom end of each Side Wall Roller Door Jamb as shown . If the Jamb sits on the slab then a Base Cleat Bracket is attached to the bottom of Each Side Wall Roller Door Jamb as shown.

GABLE END WALL WINDOW DJ CONNECTIONS



BOTTOM GIRT CUT OUT



BOTTOM GIRT CONNECTION



INTERMEDIATE GIRT CONNECTION

Fit L/H and R/H side wall door jambs and screw the two upright (uncut) legs to both sides of the GABLE END WALL GIRT ABOVE or RAFTER using Framing Screws. Plumb the jambs, and screw the bottom upright (uncut) legs to the GABLE END WALL GIRT BELOW. If the Jamb sits on the slab then drill holes in the base cleat and anchor bolt into position. Fix the door jambs at intersection of any girt(s) which were cut off.

Complete the cladding around the window and trim to exact size.

GABLE END WALL WINDOW DJ BASE CONNECTION



BASE CONNECTION

ATTACHING WINDOW TO OPENING

Position Window into Opening and fasten the protruding fin to the purlins, girts, door jambs and or wall sheets using Wall Screws or Rivets.

For more information on installing the Gable End Wall Window(s) and all associated parts, refer to the relevant supplier's recommended installation guidelines.

GABLE END WALL WINDOW



GABLE END WALL WINDOW OPENINGS



GABLE END WALL WINDOWS IN PLACE

33. INSTALLATION OF SIDE WALL GLASS SLIDING DOOR

Please read and refer to the manufacturers recommended installation material supplied with the Glass Sliding Door(s) before proceeding with this Chapter.

Installation of SIDE WALL Glass Sliding Door(s) should occur AFTER the Flashings & Downpipes have been attached.

SIDE WALL GLASS SLIDING DOOR SIZE & LOCATION

Check your Engineering Plans and Bill of Materials for Side Wall Window size(s) & location(s). Side Wall Glass Sliding Doors can be located anywhere between two sidewall columns, providing they do not interfere with any bracing already installed in the side wall.

DOOR & WINDOW SIZE(S) & LOCATION(S)

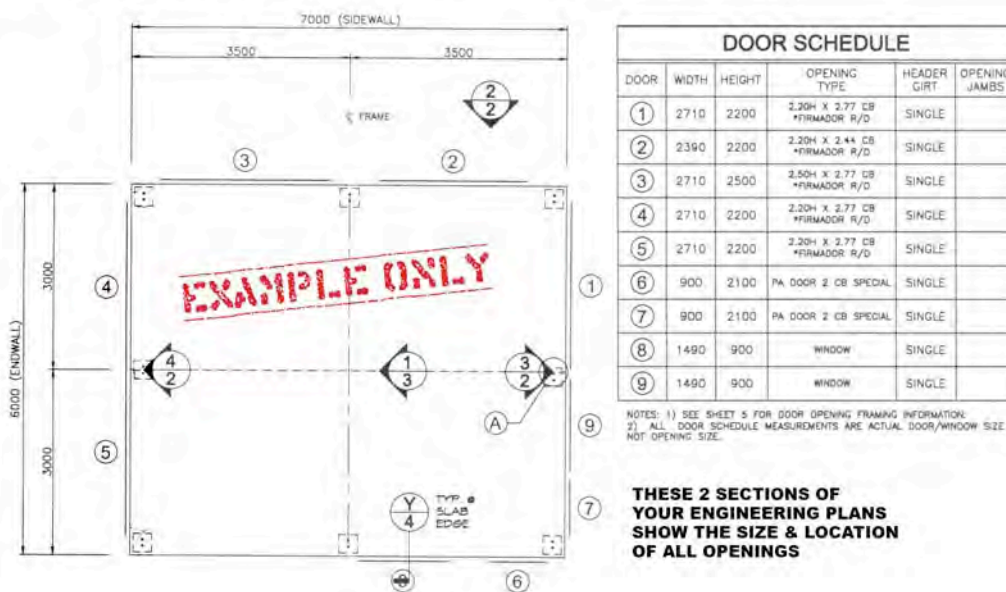

Glass Sliding Doors have a REVEAL or FIN protruding from the centre of the frame, which extends for approximately 30mm.

GLASS SLIDING DOOR EXAMPLE



FIN FITS BETWEEN WALL SHEETS & GIRTS

SIDE WALL GLASS SLIDING DOOR OPENING SIZE

Refer to the supplied manufacturers recommended installation material for instructions on how to calculate the OPENING SIZE for the glass sliding door(s) (generally exactly the same in width and height as the door itself, with a slight clearance allowance so as not to break glass when installing into opening). Mark the opening in the desired location on the side wall girts and slab for placement of Glass Sliding Door(s). Once marked, cut the opening width from the side wall girts and complete/trim side wall sheeting around either side of the opening.

SIDE WALL ROLLER DOOR JAMBS USED TO REINFORCE SIDE WALL GLASS SLIDING DOORS

If there is a side wall girt between the top of the sliding door and the eave purlin then the jambs will suit this length. IF THERE IS NO GIRT ABOVE THE OPENING, (i.e. between the top of sliding door and eave purlin) then the length of the jambs will be to the eave purlin. They are to be attached to the SIDE WALL GIRT or EAVE PURLIN, whichever comes first.

Measure length of vertical opening from the SLAB to the top of the SIDE WALL GIRT ABOVE or EAVE PURLIN to which the Side Wall Roller Door Jambs are to be attached. Side Wall Roller Door Jambs are to be trimmed to this exact length. Measure the height of the SIDEWALL GIRT or EAVE PURLIN and cut this amount out of the centre section of the top end of each Side Wall Roller Door Jamb as shown.

SIDE WALL GLASS SLIDING DOOR JAMB CONNECTIONS

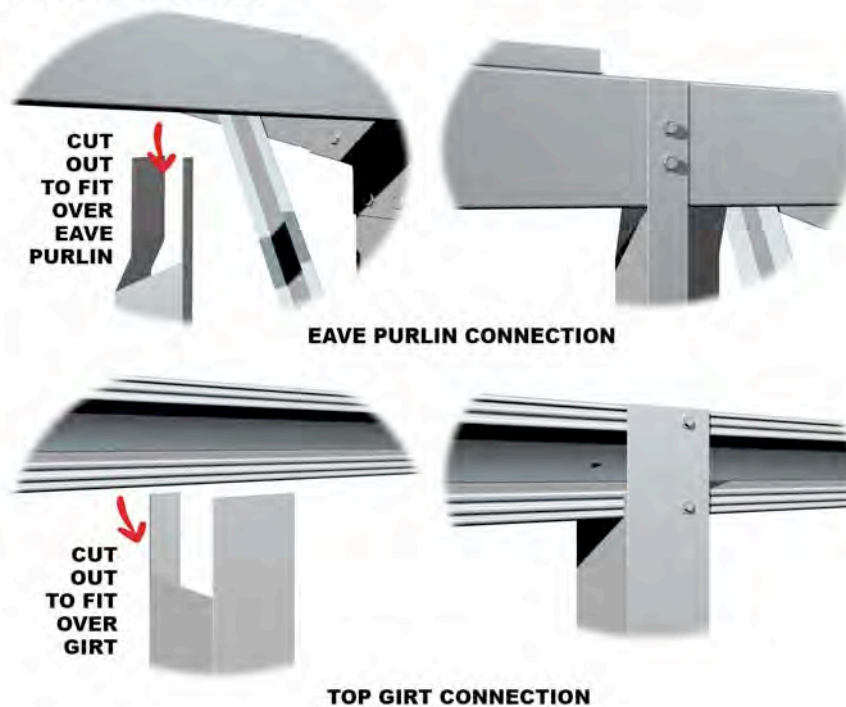

A Base Cleat Bracket is attached to the bottom of Each Side Wall Roller Door Jamb. Fit L/H and R/H side doorjamb and screw the two upright (uncut) legs to both sides of the SIDE WALL GIRT ABOVE or EAVE PURLIN using Framing Screws. Plumb the jamb and drill holes in the base cleat and anchor bolt into position. Fix the door jambs at intersection of any girt(s) which were cut off.

SIDE WALL GLASS SLIDING DOOR HEADER

The height of door header is equivalent to the height of the door opening required. Refer to the supplied manufacturers installation material for instructions on how to calculate the OPENING HEIGHT(s) for each Glass Sliding Door provided. Measure & mark the opening height for the Roller Door onto the Side Wall Glass Sliding Door Jambs. Fit the Door Header (C Section) between the jambs using Gable End Wall girt brackets and Framing Screws. Complete the cladding around the door and trim to exact size.

SIDE WALL GLASS SLIDING DOOR CONNECTIONS



BASE CONNECTION



GIRT CONNECTION



HEADER CONNECTION

ATTACHING SLIDING DOORS TO OPENING

Position Sliding Door into Opening and fasten the protruding fin to the purlins, girts, door jambs and or wall sheets using Wall Screws or Rivets.

For more information on installing the Side Wall Glass Sliding Door(s) and all associated parts, refer to the relevant supplier's recommended installation guidelines.

SIDE WALL GLASS SLIDING DOOR



SIDE WALL GLASS SLIDING DOOR OPENINGS



SIDE WALL GLASS SLIDING DOOR IN PLACE

34. INSTALLATION OF GABLE END WALL GLASS SLIDING DOORS

Please read and refer to the manufacturers recommended installation material supplied with the Glass Sliding Door(s) before proceeding with this Chapter.

Installation of GABLE END WALL Glass Sliding Door(s) should occur AFTER the Flashings & Downpipes have been attached.

GABLE END WALL GLASS SLIDING DOOR SIZE & LOCATION

Check your Engineering Plans and Bill of Materials for Gable End Wall Glass Sliding Door size(s) & location(s).

DOOR & WINDOW SIZE(S) & LOCATION(S)

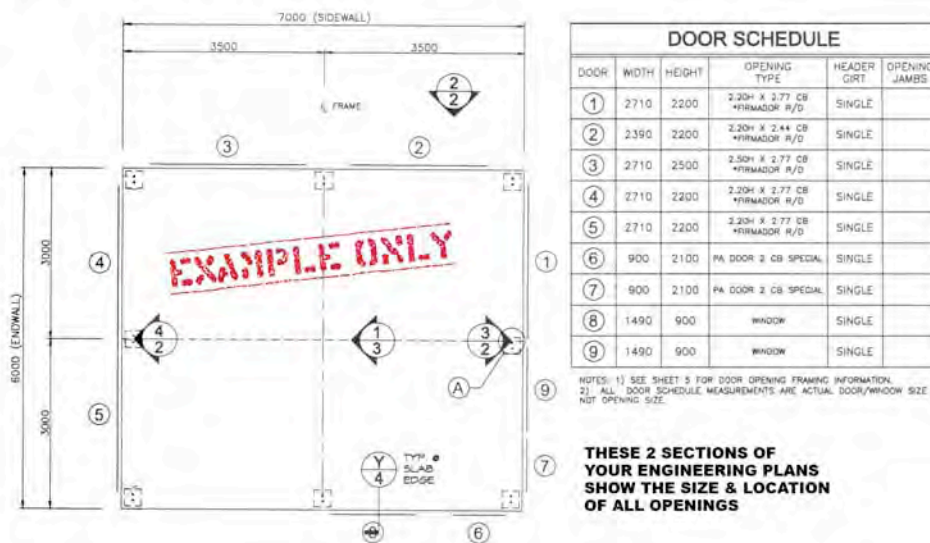

Glass Sliding Doors have a REVEAL or FIN protruding from the centre of the frame, which extends for approximately 30mm.

GLASS SLIDING DOOR EXAMPLE



GABLE END WALL GLASS SLIDING DOOR OPENING SIZE

Refer to the supplied manufacturers recommended installation material for instructions on how to calculate the OPENING SIZE for the window (generally exactly the same in width and height as the door itself, with a slight clearance allowance so as not to break glass when installing into opening). Mark the opening in the desired location on the Gable End Wall girts and Slab for placement of Glass Sliding Door(s). Once marked, cut the opening width from the Gable End Wall girts and complete/trim side wall sheeting around either side of the opening.

GABLE END WALL ROLLER DOOR JAMBS USED TO REINFORCE GABLE END WALL GLASS SLIDING DOORS

If there is an Gable End Wall girt between the top of the door and the rafter then the jambs will suit this length. IF THERE IS NO GIRT ABOVE THE OPENING, (i.e. between the top of door and rafter) then the length of the jambs will be to the rafter. The jamb is to be attached to the GABLE END WALL GIRT or RAFTER, whichever comes first. Stand each Gable End Wall Roller Door Jamb vertically and align the lip of the jamb to the door opening width mark. Level the Gable End Wall Roller Door Jamb & mark the top of the GABLE END WALL GIRT or RAFTER (*Diagonal Line*) and cut this amount out of two sides of the top end of each Gable End Wall Roller Door Jamb as shown.

Fit L/H and R/H Gable End Wall roller door jambs and screw the two upright (uncut) legs to both sides of the GABLE END WALL GIRT ABOVE or RAFTER using Framing Screws.

GABLE END WALL GLASS SLIDING DOOR JAMB CONNECTIONS

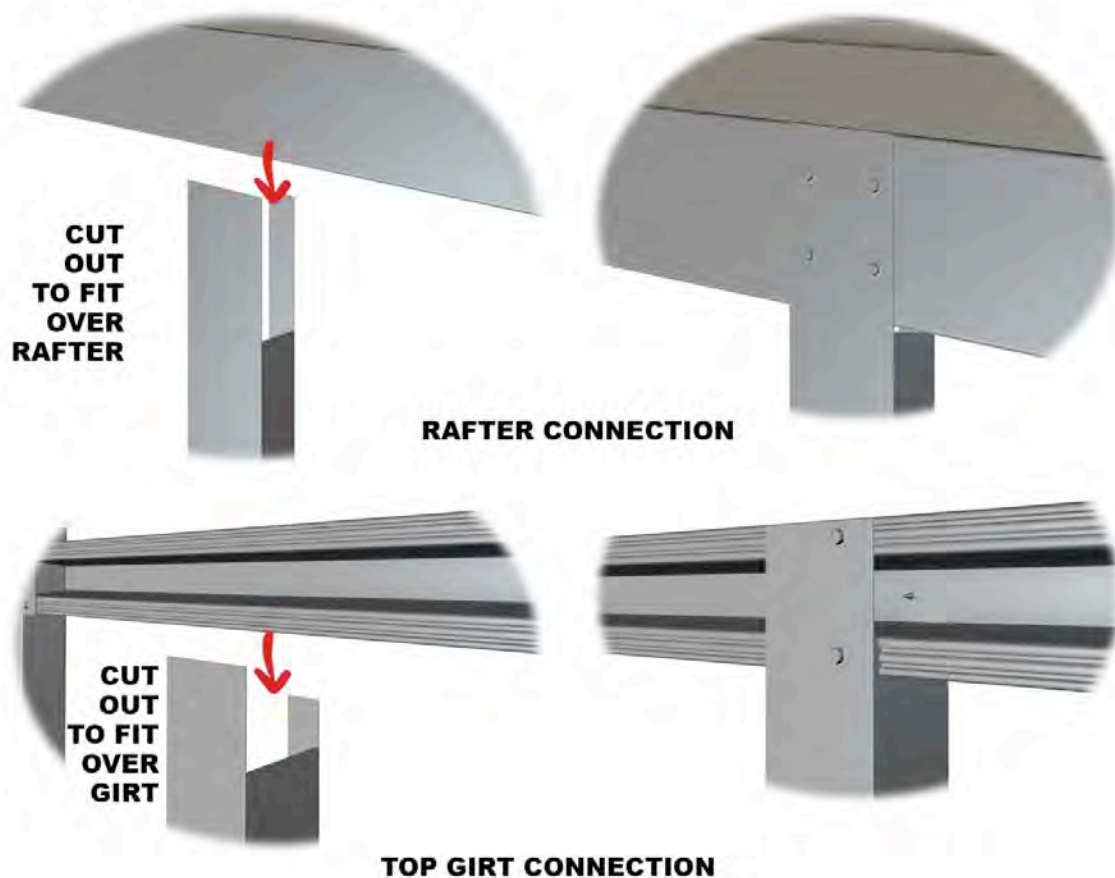

Drill holes in the base cleat and anchor bolt into position. Fix the door jambs at intersection of any girt(s) which were cut off.

GABLE END WALL GLASS SLIDING DOOR HEADER

A C Section is supplied to create the Glass Sliding Door Header. The height of the glass sliding door header is equivalent to the height of the door itself. Fit the Glass Sliding Door Header between the jambs and attach at either end to the door jambs with Gable End Wall Girt Brackets.

GABLE END WALL GLASS SLIDING DOOR CONNECTIONS



BASE CONNECTION



GIRT CONNECTION



HEADER CONNECTION

ATTACHING GABLE END WALL SLIDING DOOR TO OPENING

Position Sliding Door into Opening and fasten the protruding fin to the purlins, girts, door jambs and or wall sheets using Wall Screws or Rivets.

For more information on installing the Gable End Wall Glass Sliding Door(s) and all associated parts, refer to the relevant supplier's recommended installation guidelines.

GABLE END WALL GLASS SLIDING DOOR

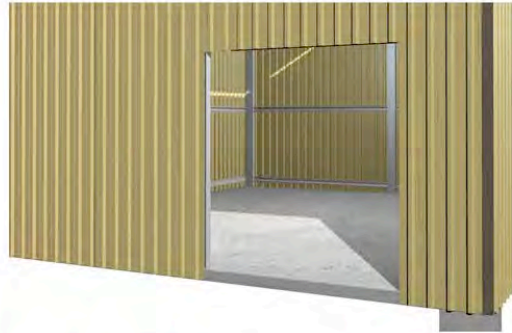

GABLE END WALL GLASS SLIDING DOOR OPENINGS



GABLE END WALL GLASS SLIDING DOOR IN PLACE